

User Manual

Modular Online UPS

Uninterruptible Power Supply System

Version: 1.5

Table Of Contents

1. Safety	1
1.1 Important Safety Instructions.....	1
1.2 EMC.....	1
1.3 Installation information	1
1.4 Maintenance	2
1.5 Recycling the used battery	2
2. Installation	3
2.1 Mechanism and Exterior.....	3
2.2 Internal Mechanisms.....	7
2.3 Control Panel & interface	10
2.4 Installation and Wiring.....	11
2.5 Modules.....	14
2.6 Power Cable.....	20
3 Operation & structure.....	22
3.1 Operation Mode.....	23
3.2 Operation Instructions	24
4. Control Panel and Display Description	29
4.1 Introduction	29
4.2 Screen Description.....	31
4.3 Alarm List	46
5. Interface and Communication	49
5.1 Remote EPO Input Port.....	49
5.2 BCB Port	50
5.3 Maintenance Bypass Switch State Port.....	51
5.4 Internal Output Switch State Port	51
5.5 Battery Cabinet Temperature Detection Port.....	52
5.6 Bypass back feed Control Port.....	52
5.7 Battery breaker Control Port.....	53
5.8 Other Communication Interface.....	53
6 Service	54
6.1 Replacement Procedures Of Power Module, STS & Control Module And Battery Module	54
6.2 Replacement Procedures Of Air Filter	56
7 Specifications.....	57
7.1 Conformity And Standards	57
7.2 Environmental Characteristics	57
7.3 Mechanical Characteristics	58
7.4 Electrical Characteristics (Input Rectifier)	58
7.5 Electrical Characteristics (Intermediate DC Circuit)	59
7.6 Electrical Characteristics (Inverter Output).....	59
7.7 Electrical Characteristics (Bypass Mains Input)	60

1. Safety

1.1 Important Safety Instructions

This UPS contains LETHAL VOLTAGES. All repairs and service must be performed by AUTHORIZED SERVICE PERSONNEL ONLY. There are NO USER SERVICEABLE PARTS inside the UPS.

WARNING:

- The UPS designed for commercial and industrial purpose, it is forbidden to apply for any life sustainment and support.
- The UPS system contains its own energy source. The output terminals may carry live voltage even when UPS is disconnected from an AC source.
- To reduce the risk of fire or electrical shock, UPS installation has to be in a temperature and humidity controlled, indoor environment. Ambient temperature must not exceed 40°C. The system is not intended for outdoor use.
- Ensure all power is disconnected before performing installation or service.
- Service and maintenance should be performed by qualified service personnel only.

Before working on this circuit

- Isolate Uninterruptible Power System (UPS)
- Then check for Hazardous Voltage between all terminals including the protective earth.



Risk of Voltage Backfeed

The isolation device must be able to carry the UPS input current.

1.2 EMC

WARNING:

This is a product for commercial and industrial application in the second environment - installation restrictions or additional measures may be needed to prevent disturbances.

1.3 Installation information

WARNING:

- Installation must be performed by qualified personnel only.
- The cabinets must be installed on a level floor suitable for computer or electronic equipment.
- The UPS cabinet is heavy. If unloading instructions are not closely followed, cabinet may cause serious injury.
- Do not tilt the cabinets more than 10° .
- Ground conductor is properly installed.
- Installation and Wiring must be performed in accordance with the local electrical laws and regulations.
- The disconnection device should break line and neutral conductors- four poles for three phases.

1.4 Maintenance

- UPS is designed to supply power even when disconnected from the utility power. After disconnect the utility and DC power, authorized service personnel should attempt internal access to the UPS.
- Only qualified service personnel should perform the battery installation.
- Do not disconnect the batteries while the UPS is in Battery mode.
- Disconnect the charging source prior to connecting or disconnecting terminals.
- Batteries can present a risk of electrical shock or burn from high short circuit current.
- The following PRECAUTIONS should be observed
 1. Remove watches, rings, or other metal objects.
 2. Use tools with insulated handles.
 3. Wear rubber gloves and boots.
 4. Do not lay tools or metal parts on top of batteries or battery cabinets.
 5. Disconnect the charging source prior to connecting or disconnecting terminal.
 6. Determine if the battery is inadvertently grounded. If it is, remove the source of the ground. Contact with any part of a grounded battery can result in electrical shock. The likelihood of such shock is reduced if such grounds are removed during installation and maintenance.
- When replacing batteries, use the same number of sealed, lead-acid batteries.
- Do not dispose of battery in a fire. The battery may explode.
- Do not open or mutilate the battery. Release electrolyte is harmful to the skin and eyes, and may be toxic.

1.5 Recycling the used battery

- Do not dispose of the battery in a fire. Battery may explode. Proper disposal of battery is required. Refer to your local codes for disposal requirements.
- Do not open or mutilate the battery. Released electrolyte is harmful to the skin and eyes. It may be toxic.
- Do not discard the UPS or the UPS batteries in the trash. This product contains sealed, lead-acid batteries and must be disposed of properly. For more information, contact your local recycling/reuse or hazardous waste center.
- Do not discard waste electrical or electronic equipment (WEEE) in the trash. For proper disposal, contact your local recycling/reuse or hazardous waste center.

2. Installation

2.1 Mechanism and Exterior

In the front of the UPS, there are control interface (LCD Panel) and door lock. Inside the cabinet, there are an STS Module, 1~8 Power Module slots and Battery modules.

All wiring terminal blocks are allocated in the back of system. The side panels are lockable. The casters at the bottom of the UPS cabinet can be used to move over short distances. There are four leveling feet to fix and stabilize the UPS cabinet on the ground.

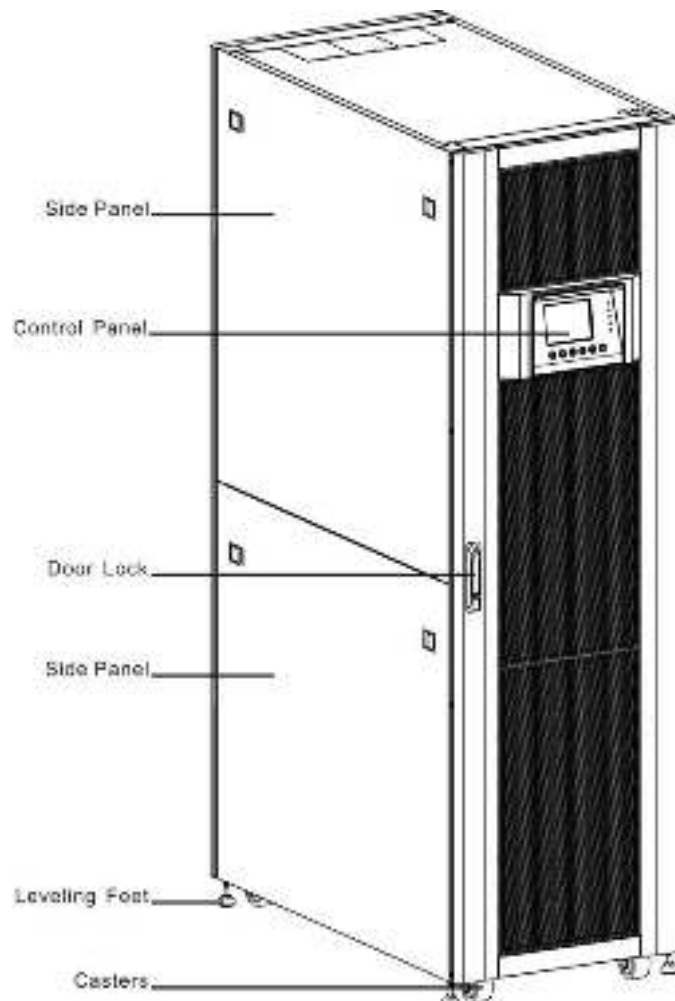
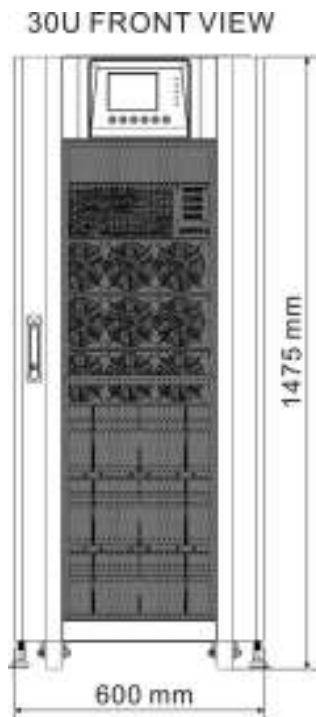
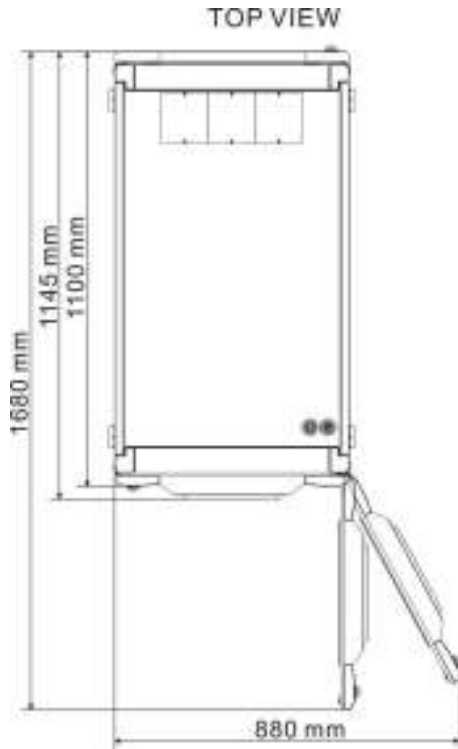


Figure 2-1: UPS Exterior

2.1.1 Mechanical Data

Dimensions			
UPS cabinet	Width	Depth	Height
30~90Kw(30U)	600mm	1100m	1475mm
30~210Kw(42U)	600mm	1100m	2010mm



42U FRONT VIEW

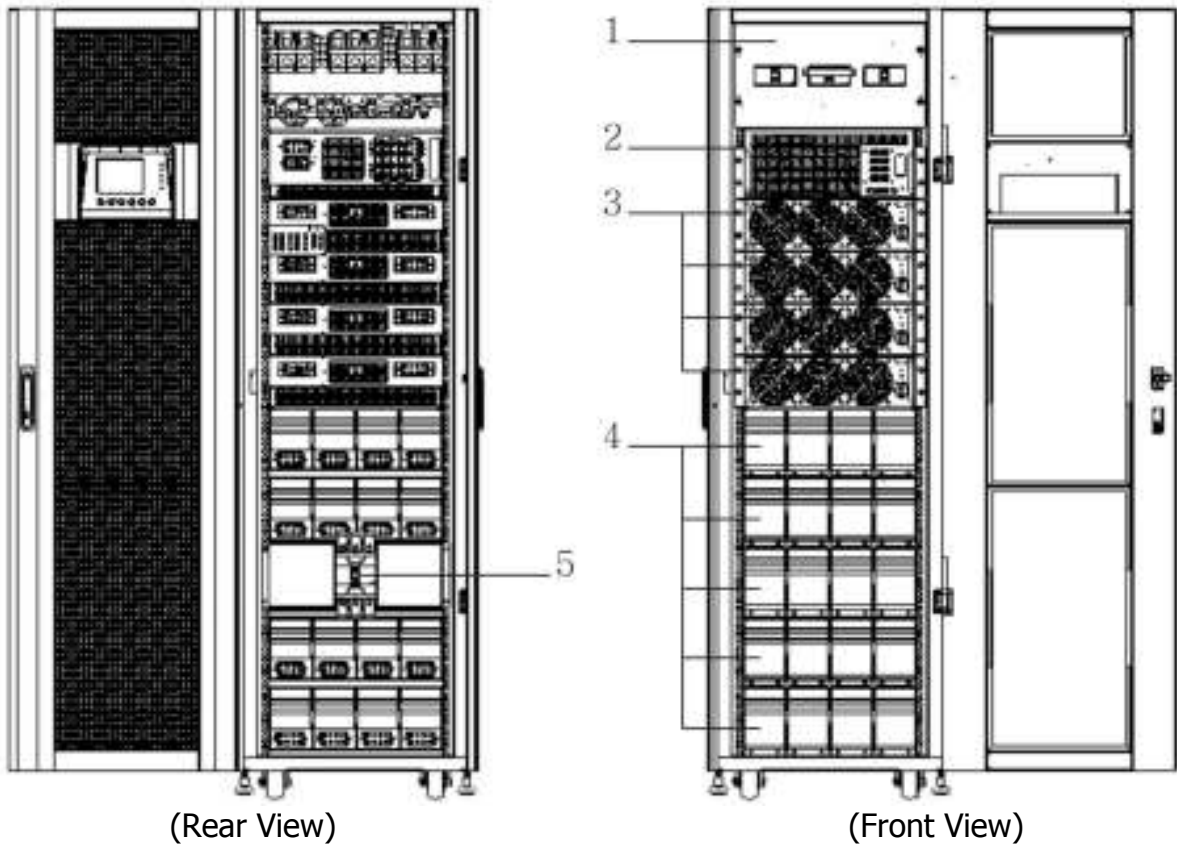


Figure 2-2: Dimensions

2.1.2 Other Views

Front View : Unlock and open the front door to see STS Module, Switch unit, Power Module and Battery Module.

Rear View : Unlock and open the rear door to see Battery Breaker.



1. Switch unit
2. Bypass module
3. Power module
4. Battery module
5. Battery breaker

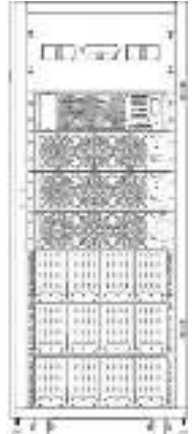
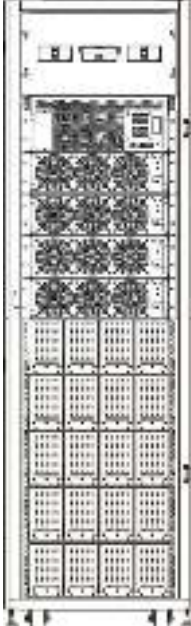



Figure 2-3: Front and Rear View

Configurations:

There are two basic configurations for different applications.

It's required to have battery modules for Standard Series.

Please consider the external battery space and wiring gauge for Extended Series.

	Standard Series		Extended Series		
Photo					
Cabinet Height	30U	42U	30U	30U	42U
Switch Unit	1	1	1	1	1
STS	1	1	1	1	1
Max. Power Module	3	4	4	6	8
Battery Module	12	20	N/A	N/A	N/A

2.2 Internal Mechanisms

After opening the front door, you can see the Switch unit, Bypass module, Power module and Battery module. After opening the back door, you can see the Battery Breaker and input/ output wiring terminal block. Please refer to the following sections.

2.2.1 Input and Output Breakers

Open front and back door. The Input Breaker, Bypass Breaker and Output Breaker are located on the front of the UPS. The Battery Breaker and input/ output wiring terminal block are at the back of the UPS. See Figure 2-4.

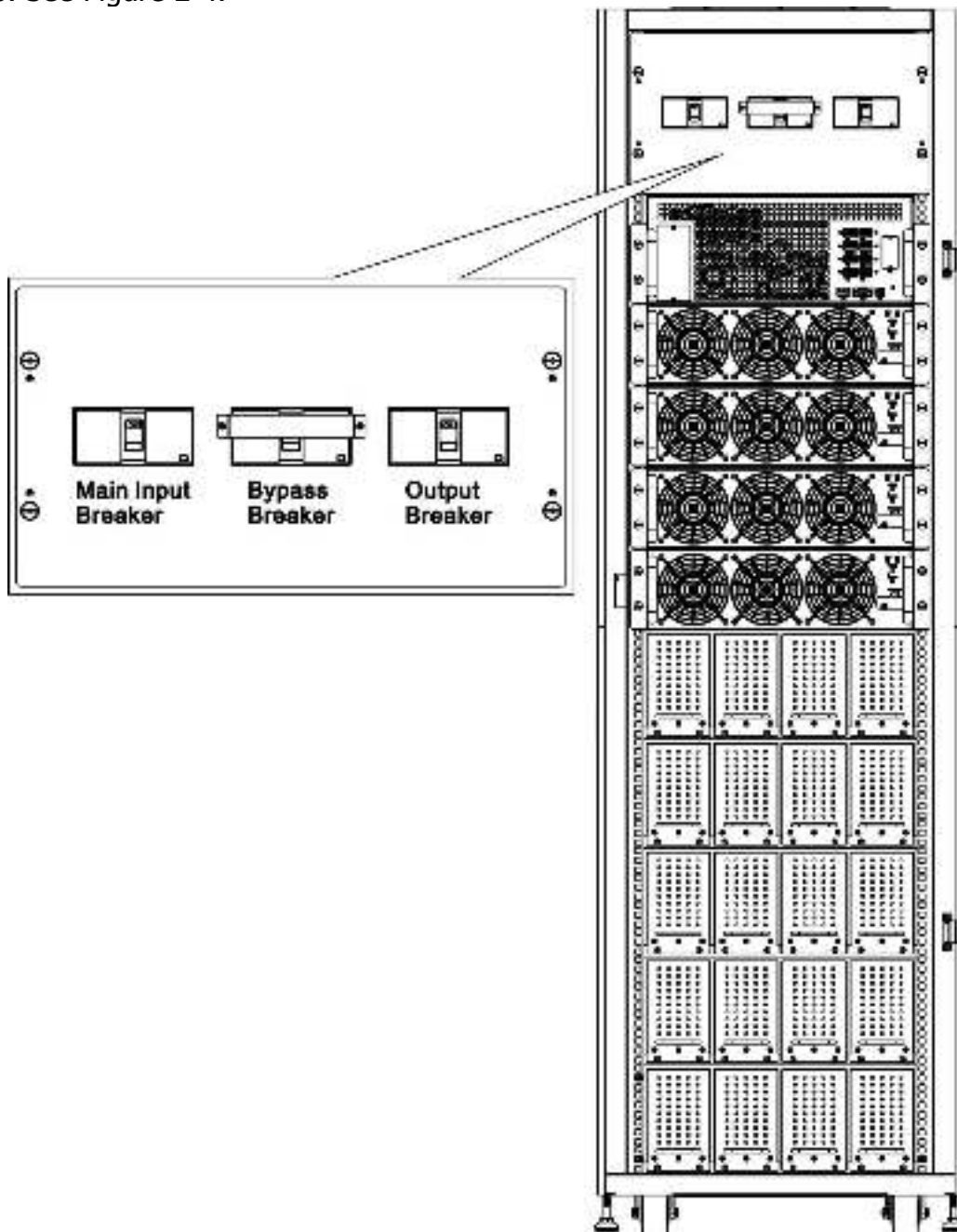


Figure 2-4: Front View/Output, Bypass, and Main Input Breakers

2.2.2 Wiring Terminal Block

Open the UPS's back doors and you will see the wiring terminal block. For connection instructions, please refer to Figure 2-5.

Item	Function	Description
Output Block	Connects the critical loads	Includes R, S, T and Neutral terminals.
Bypass Input Block	Connects bypass AC source	Includes R, S, T and Neutral terminals.
Main Input Block	Connects main AC source	Includes R, S, T and Neutral terminals.
For UPS Grounding	For UPS grounding	Includes one grounding terminal.
Battery Input Block	Connects an external battery cabinet	Includes Positive (+), Negative (-) and Neutral (N) terminals.

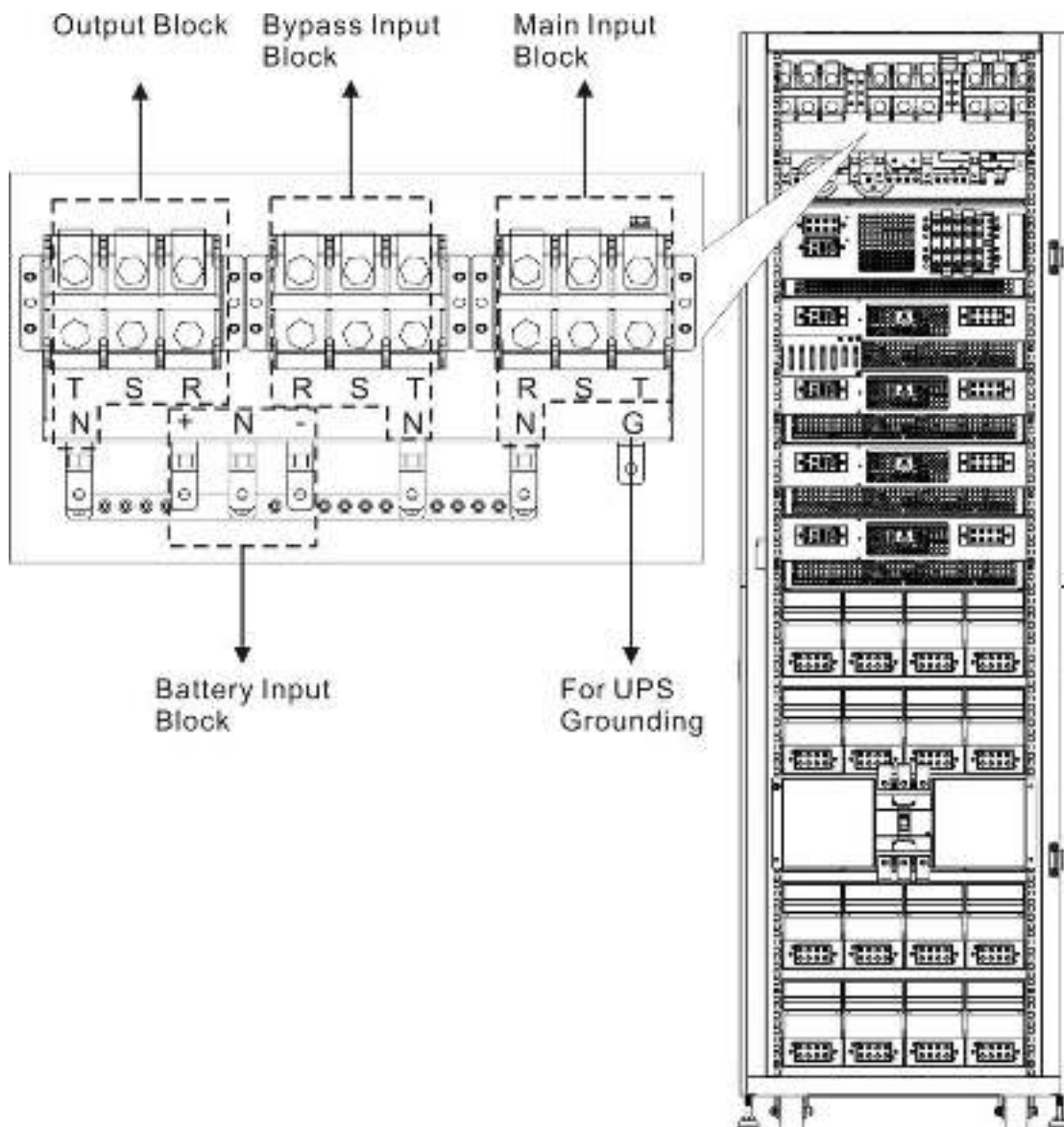


Figure 2-5: Rear View & Wiring Terminal Block

2.2.3 Modules

The STS & Control module and Power Module allow quick maintenance, replacement and expansion. The module latches secure the modules in place.

- STS & Control Module: It includes control, power, communication circuits, an internal Static Transfer Switch and a fuse.
- Power Module: Each power module capacity is 30kVA/ 30kW. It includes a power factor correction rectifier, a battery charger, an inverter and control circuits.
- Battery Module: It contains 10 pcs of 12V/9Ah batteries inside.

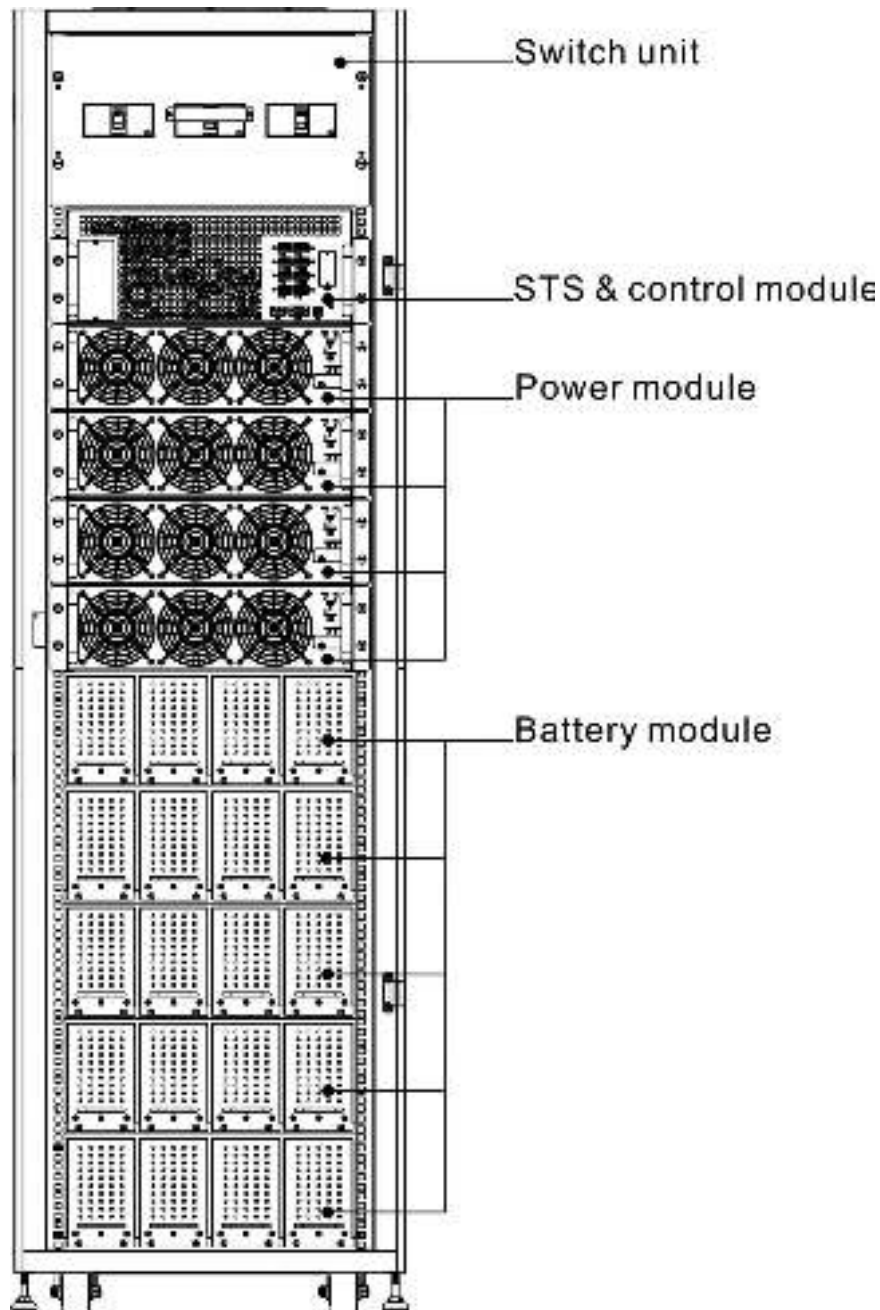


Figure 2-6: Front View with Modules

2.3 Control Panel & interface

The front access Graphic Display & Control interface brings all measured parameter, UPS & Battery current states and Alarms. Through the interface, users can easily monitor status and configure settings. For detailed information, please refer to the chapter 4.

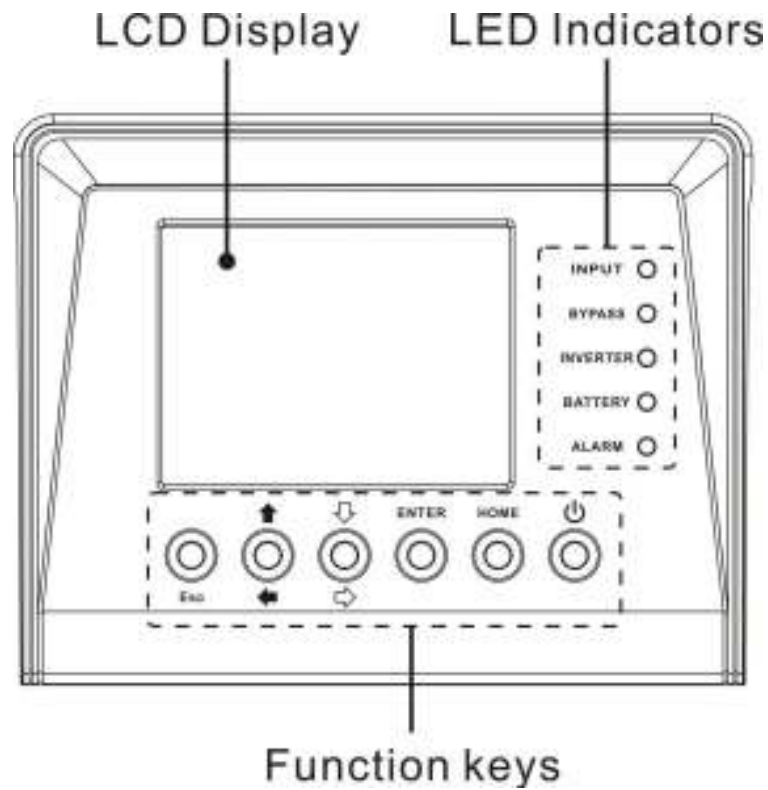


Figure 2-7: Control Panel

2.3.1 LED indications

LED	Color	Status	Definition
INPUT	Green	On	Input source is normal.
		Flashing	Input source is abnormal.
		Off	No input source
BYPASS	Green	On	Load on Bypass.
		Flashing	Input source is abnormal.
		Off	Bypass not operating.
INVERTER	Green	On	Load on inverters.
		Off	Inverters not operating.
BATTERY	Yellow	On	Load on Battery.
		Flashing	Low battery
		Off	Battery converter is normal and battery is charging.
ALARM	Red	On	UPS fault.
		Flashing	UPS alarm.
		Off	Normal.

2.3.2 LCD Display

Graphic display and all measured parameters.

2.3.3 Function Keys

Control Key	Description
Esc	Return to previous screen or cursor displacement. When screen is in Main screen, it will enter setting menu by pressing ESC key.
Up(Left)	Key for menu page navigation or digit modification.
Down(Right)	Key for menu page navigation or digit modification.
Enter	Confirmation of commands, or cursor displacement.
Home	Return to Main screen.
Power On/Off	Turn on UPS or Turn off UPS.

2.4 Installation and Wiring

2.4.1 Before Installation

Due to different installation environments, please read this user manual thoroughly before installation and wiring. Only authorized engineers or service personnel can perform installation and maintenance. If you want to install the UPS by yourself, installation must be under the supervision of authorized engineers or service personnel.

If you use a forklift or other equipment to move the UPS, please make sure its load bearing is sufficient.

2.4.2 Installation Environment

- The UPS is designed for indoor use only. Do not install or place it in an outdoor area.
- Make sure that transportation routes (e.g. corridor, door gate, elevator, etc) and installation area can accommodate and bear the weight of the UPS, the external battery cabinet and handling equipment.
- Ensure that the installation area is big enough for maintenance and ventilation.
- Keep the installation area's temperature around 30°C and humidity within 90%. The highest operating altitude is 2000 meters above sea level.
- The UPS is intended for indoor installation and should be located in an environment with clean air and with adequate ventilation to keep the ambient temperature within the specified operating range. The UPS is air-cooled with the aid of internal fans. Cold air enters the UPS through.
- If necessary, install a system of room extractor fans to avoid room temperature build-up. Air filters are necessary if the UPS is operated in a dusty environment.

Note: The UPS is suitable for mounting on concrete or other non-combustible surface only.

- The UPS is air-cooled with the aid of internal fans. Cold air enters the UPS through the ventilation grilles at the front of the cabinet and hot air is released through the grilles at the back. Do not cover the ventilation openings.
- Do not allow unauthorized personnel to enter the installation area. Assign specific personnel to keep the UPS key.


For safety concerns, we suggest that you shall:

1. Surroundings of the installation area with CO2 or dry powder fire extinguishers.
2. Install the UPS in an area where the walls, floors and ceilings were constructed by fireproof materials.

It is recommended that you parallel the external battery cabinets to the UPS. The following clearances are suggested:

1. Keep a clearance of 100cm from the top of the UPS for maintenance, wiring and ventilation.
2. Keep a clearance of 100cm from the back of the UPS and the external battery cabinets for ventilation.
3. Keep a clearance of a 150cm from the front of the UPS and the external battery cabinets for maintenance and ventilation.

2.4.3 Transportation

 Warning
The UPS is fixed on the pallet with four balance supports. When removing them, pay attention to the movement of the casters to avoid accidents. The cabinet can be pushed forward or backward only. Pushing it sideward is not allowed. When pushing the cabinet, take care not to overturn it as the gravity center is high.

- If you need to move the UPS over a long distance, please use appropriate equipment like a forklift. Do not use the UPS casters to move the over a long distance.
- After the UPS has been removed from the pallet to ground, we suggest that at least three people move the UPS to the installation area. One person use hands to hold a lateral side of the UPS, one person hold the other lateral side of the UPS with hands, and one person use hands to push the UPS either from the front side or from the backside to move the unit to the installation area and avoid tipping the UPS.
- The casters are designed to move on level ground. Do not move the UPS on an uneven surface. This might cause damage to the casters or tip the UPS which could damage the unit.
- Ensure that the UPS weight is within the designated surface weight loading of any handling equipment.
- At the bottom of the UPS, there are four casters to help you to move the UPS to a designated area. Before you move the UPS, please turn the four leveling feet counterclockwise to raise them off the ground. This protects the leveling feet from damage when moving the UPS. Please use sufficient manpower(at least six people) and equipment (e.g. forklift) to carefully move the UPS from its pallet to ground. Please pay attention to the movement of the casters to avoid accidents.

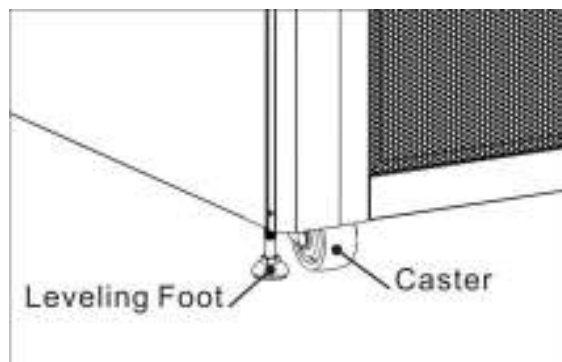


Figure 2-8: Leveling foot and caster

2.4.4 Unpacking

After shipping the product to the user first check the packaging to determine intact, and then open the package, check the equipment in good condition. If damaged, please immediately notify the carrier.

2.4.4.1 System Packaging

1. Use a forklift to move the product to installed area. Refer to Figure 2-9.
2. Please follow the order in Figure 2-10 to remove carton and foams.

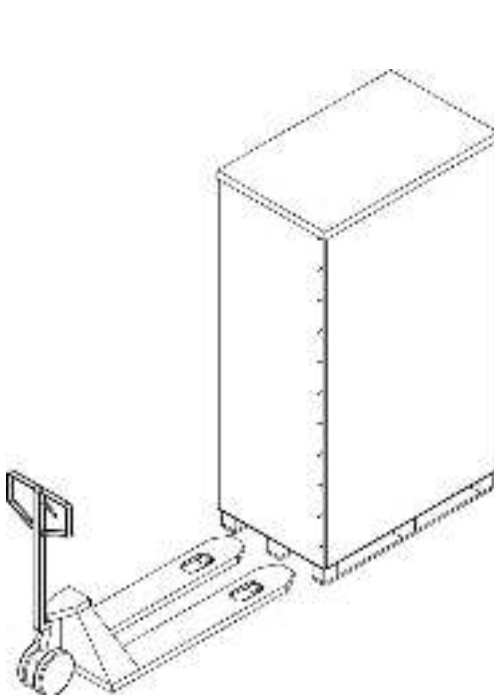


Figure 2-9

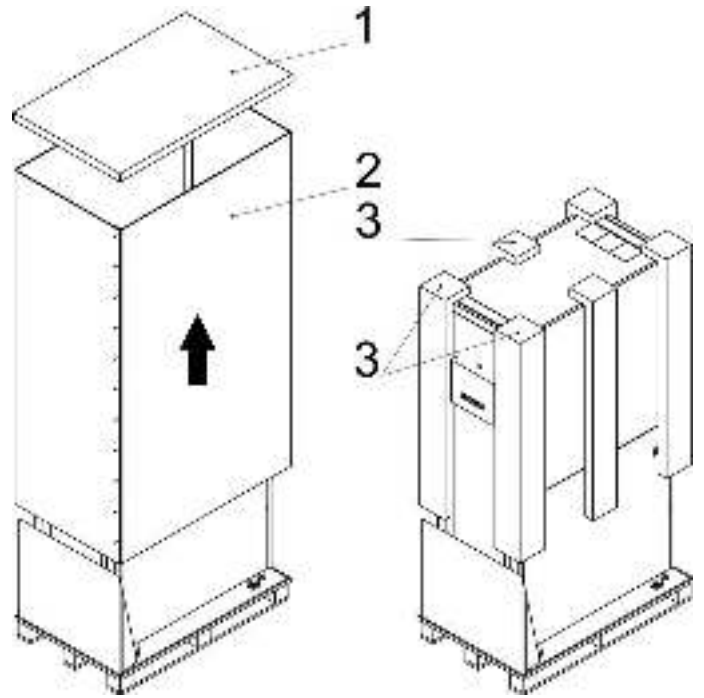


Figure 2-10

3. Put a ramp in the front of the cabinet and insert small wood into groove. Then, remove two side panels. Refer to Figure 2-11.

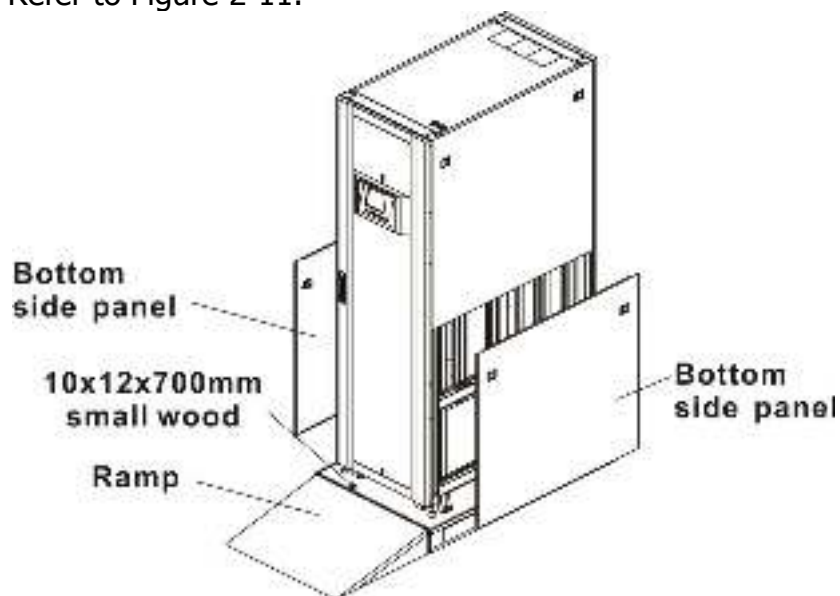


Figure 2-11

4. Remove 4 fixing cabinet plates and loosen leveling feet by rotating in counterclockwise. Then, move the cabinet from the pallet.
5. To fix the cabinet in position, simply rotate leveling feet in clockwise.

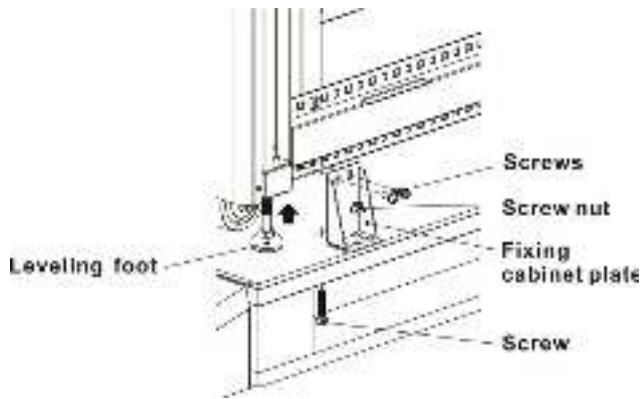


Figure 2-12

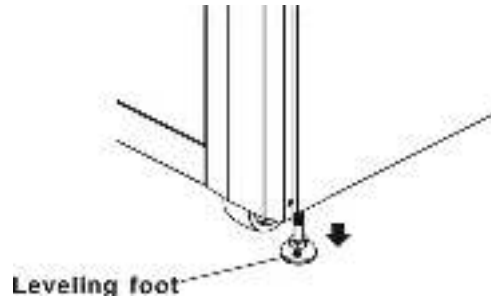


Figure 2-13

2.4.5 Positioning

Leveling feet are provided at the bottom of the UPS cabinet to prevent the UPS from moving once it has been placed to its final position. For optimal design life, the installed place must be:

- easy connection
- enough space to easily work on the UPS
- sufficient air exchange to dispel heat produced by UPS
- protection against atmospheric agents
- protection against excessive humidity and high heat sources
- protection against dust
- compliance with the current fire prevention requirements
- For VRLA (Valve Regulated Lead Acid) batteries the operating environment temperature is kept between 20°C and 25°C. VRLA batteries are at maximum efficiency in this temperature range

2.5 Modules

The hot-swappable Power Modules allow quick maintenance and expansion. A latch located on the front of each module fixes and locks the module in its assigned slot. Each Power Module has an LED indicator to show its operation status.

2.5.1 Power Module

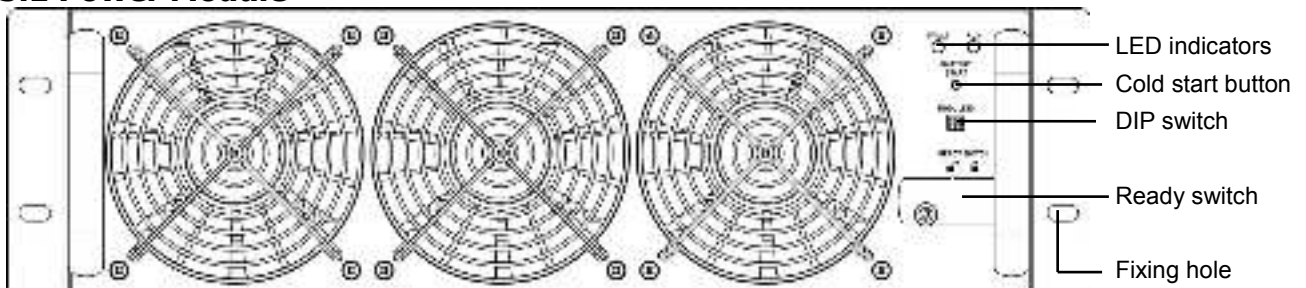


Figure 2-14: Power module

The Power Module's LED indicator shows its operation status. Please refer to the following table:

No.	LED indicator	Description
1	FAULT	Steady red LED indicates that the system is abnormal.
2	FAULT	Flashing red LED indicates that the system is in parallel abnormal.
3	RUN	Flashing green LED indicates normal operation of the host UPS.
4	RUN	Steady green LED indicates normal operation of the slave UPS.

2.5.2 Install a Power Module

Follow below procedures to install the power module.

1. Use the DIP switch on the front panel of each Power module to set the module address. The setting range is from 1 to 3. The module address should be exclusive. The setting method is shown in Table 2-1.

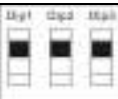
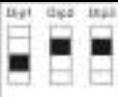
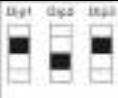
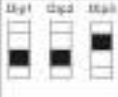
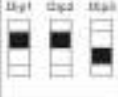

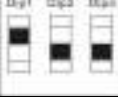

Module address	MODULE	DIP SWITCH	Parallel board
0	POWER		SW1 and SW2 DIP Parallel board is located at the back of UPS cabinet. The appearance is shown in figure 2-15.
1	POWER		
2	POWER		
3	POWER		
4	POWER		
5	POWER		
6	POWER		
7	POWER		

Table 2-1 DIP switch setting method

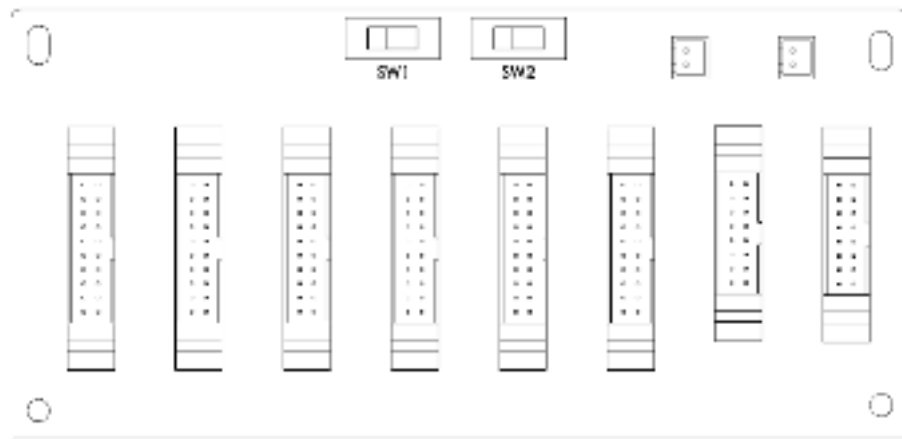






Figure 2-15 Parallel board

2. Place the ready switch on the front panel of the module to the “” position (i.e., in unready state).
3. Insert one power module in the installation position and push it into the cabinet.
4. Secure the module to the cabinet through the fixing holes on both sides of the front panel of the module.
5. Place the ready switch to the “” position (i.e., in ready state).

2.5.3 Remove a Power Module

 Warning
<p>Before removing any Power Module, make sure the remaining Power Modules can support the critical loads.</p>

1. Turn the ready switch to the “” position.
2. The Power Module LED indicator is off to indicate the Power Module discharged and shut down completely.
3. Use a screwdriver to remove the four screws from fixing holes.
4. Two people pull out together and remove the Power Module from its slot.

2.5.4 STS Module

For detail settings, please refer to chapter 5.



Figure 2-16: STS module

2.5.5 Remove the STS Module

Warning

1. Only qualified service personnel can perform the following procedures.
2. The STS Module has been pre-installed in the factory. Only remove the STS Module when maintenance or replacement is necessary.
3. When the UPS is in Bypass Mode and its critical loads are connected, removing the STS Module without turning off the Bypass Breaker could generate high voltage, which may melt its connectors.
4. If the UPS is in Bypass Mode, cutting off the bypass AC source will terminate power supply to the critical loads.
5. The STS Module is heavy (>30 kg). At least two people are required for handling.

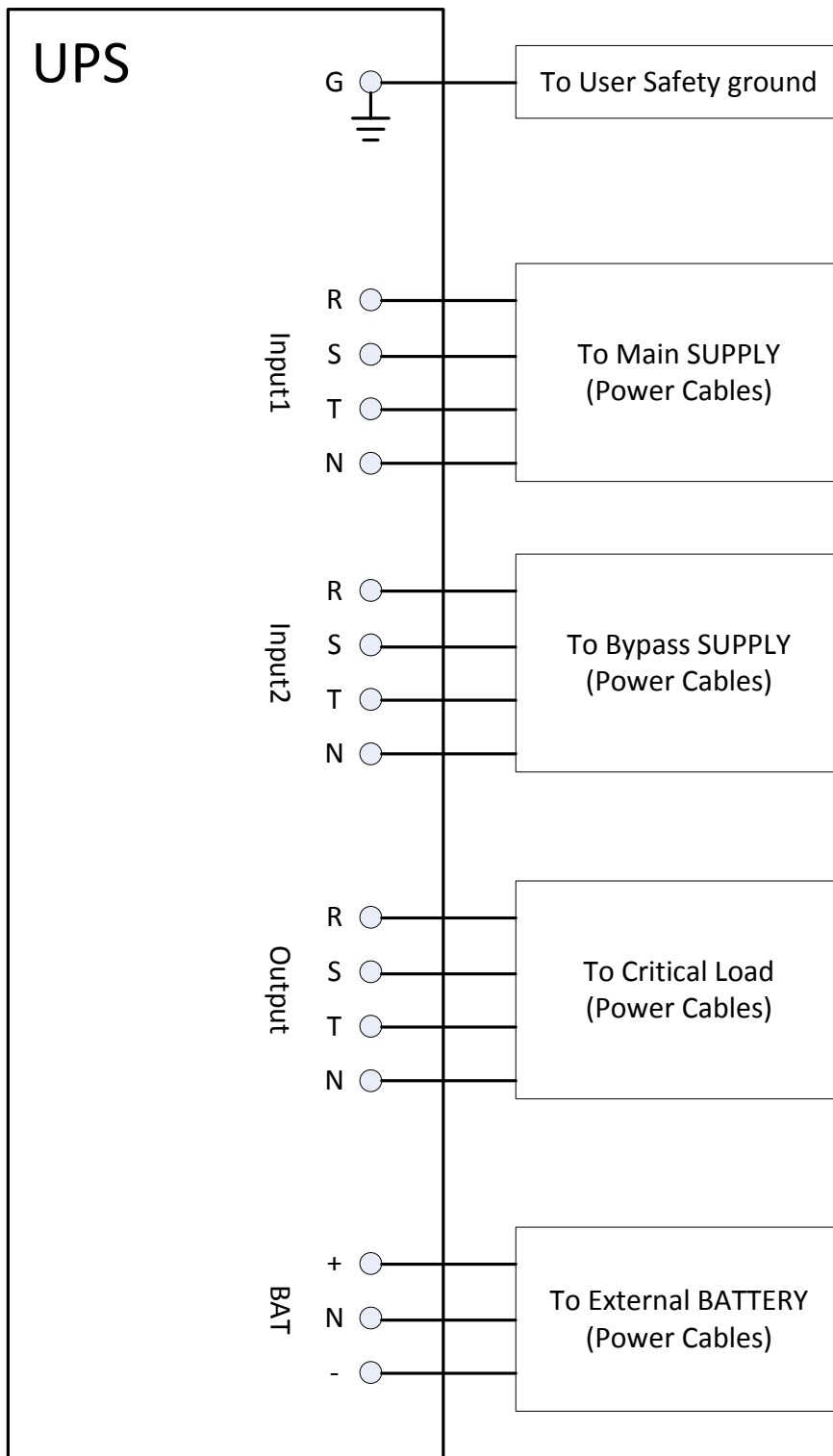
Please follow the steps below to remove the STS Module.

1. Turn OFF the Bypass Breaker.
2. Use a Screwdriver to remove the four screws from the two sides of the STS Module.
3. Two people together pull out and remove the STS Module.

NOTE: Reverse the steps above to insert the STS module.

2.5.6 UPS cabinet Installation

Please follow below chart to connect wires to UPS cabinet. (refer to 2.2.2 Wiring Terminal Block)



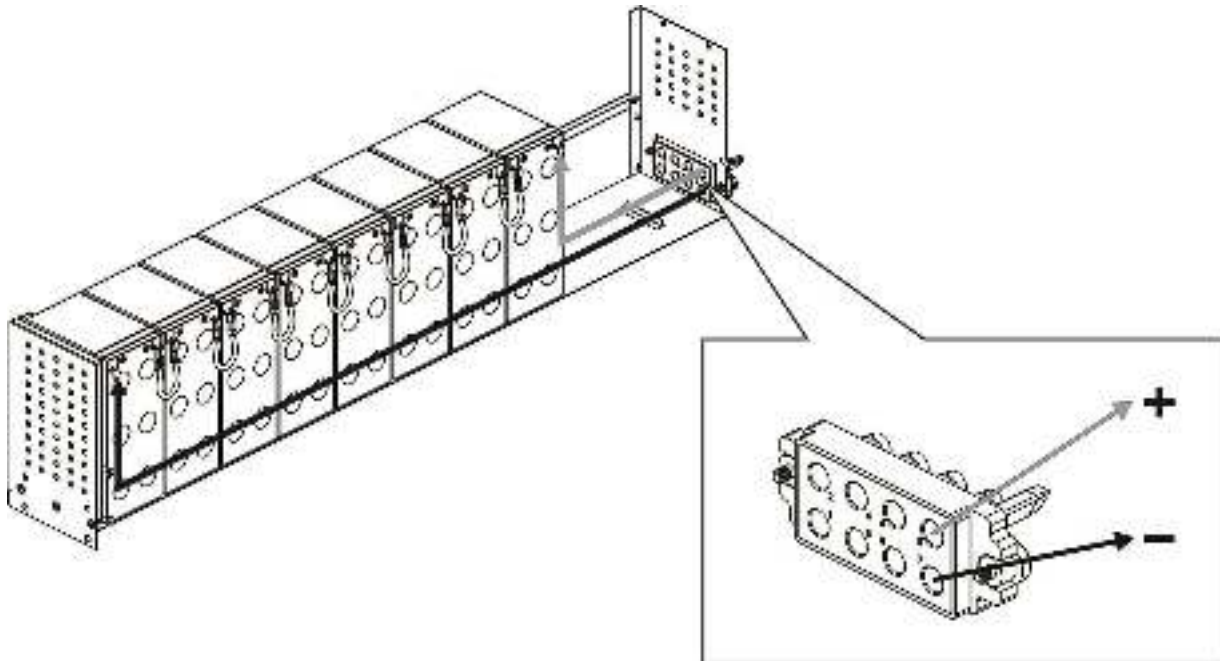
NOTE:

1. INPUT1 provides the AC power to Power Module
2. INPUT2 provides the AC power to STS Module
3. Connect INPUT1 and INPUT2 together, if they are the same power source.

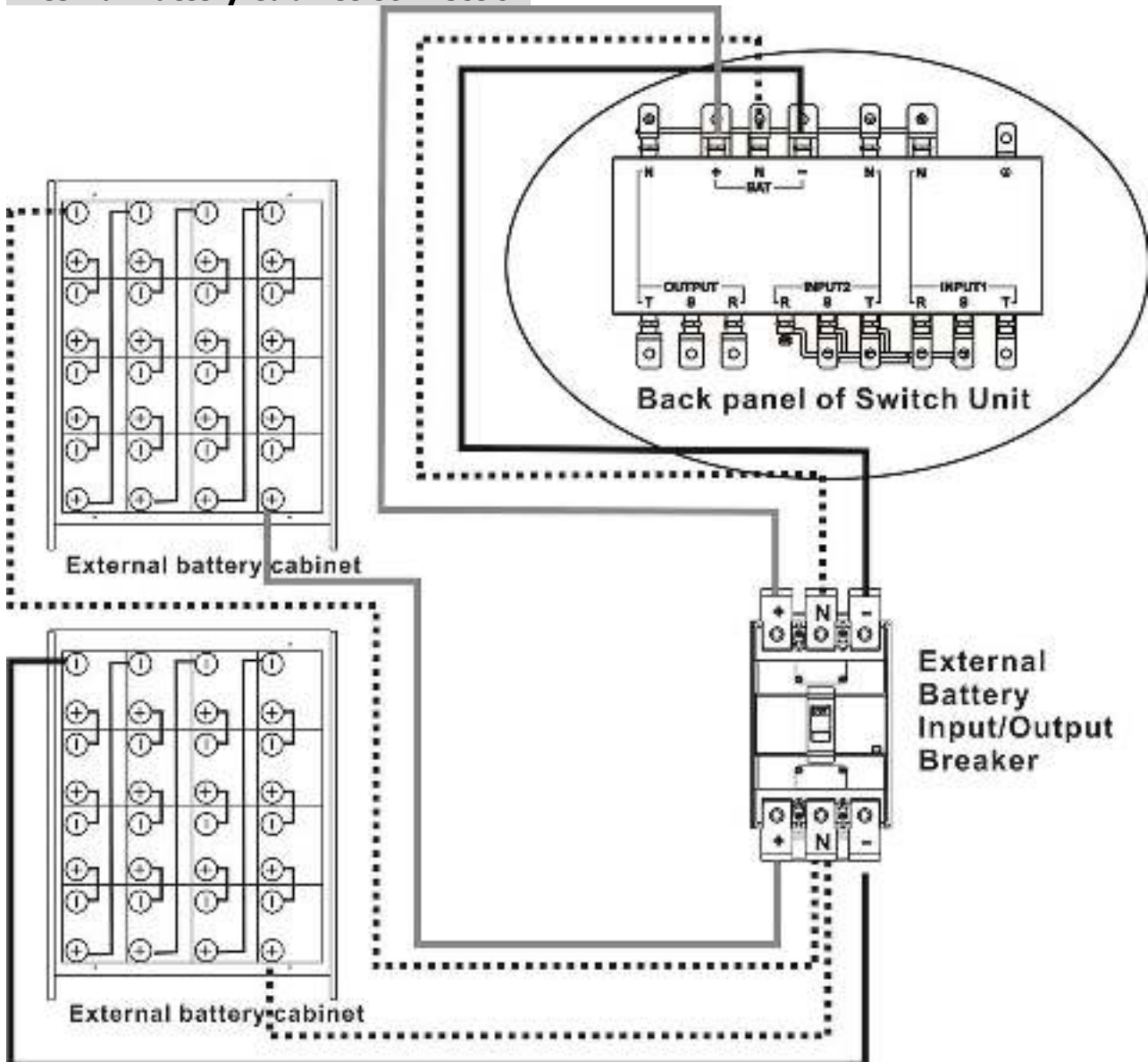
2.5.7 Battery Installation

Please follow below charts to install and connect wires to internal battery modules and external battery cabinet.

Internal Battery Module Connection



External Battery Cabinet Connection



After battery is completely installed, be sure to set up nominal battery voltage, battery capacity and maximum charging current in LCD setting. Otherwise, if battery setting is different from real installation, the UPS will keep warning. Please refer to section 4.2.6.3 and Table 5-17 for the details.

2.6 Power Cable

Warning

Please follow the local wiring regulations. Follow environmental conditions and refer to IEC60950-1.

2.6.1 AC input and output maximum current and power cable configuration.

For standard model in 30U cabinet (battery inside)

Model	30KVA	60KVA	90KVA
Current (A)	57	114	171
Power cable (mm ²)	10	35	70
Fixation torque force (lb-in)	20	20	20

For standard model in 42U cabinet (battery inside)

Model	30KVA	60KVA	90KVA	120KVA
Current (A)	57	114	171	228
Power cable (mm ²)	10	35	70	95
Fixation torque force (lb-in)	20	20	20	20

For extended series in 30U & 42U cabinet

Model	30KVA	60KVA	90KVA	120KVA	150KVA	180KVA	210KVA
Current (A)	57	114	171	228	285	342	399
Power cable (mm ²)	10	35	70	95	150	240	300
Fixation torque force (lb-in)	20	20	20	20	20	20	20

Notice: Installer has to consider the max. current and wiring gauge as possible for future extension.

2.6.2 DC input maximum current and power cable configuration.

For standard series in 30U cabinet (battery inside)

Model	30KVA	60KVA	90KVA
Current (A)	100	200	300
Power cable (mm ²)	25	95	150
Fixation torque force (lb-in)	20	20	20

Notice: 90KVA is required to set up external battery cabinet for standard model.

For standard series in 42U cabinet (battery inside)

Model	30KVA	60KVA	90KVA	120KVA
Current (A)	100	200	300	400
Power cable (mm ²)	25	95	150	240
Fixation torque force (lb-in)	20	20	20	20

Notice: 120KVA is required to set up external battery cabinet for standard model.

For extended series in 42U cabinet

Model	30KVA	60KVA	90KVA	120KVA	150KVA	180KVA	210KVA
Current (A)	100	200	300	400	500	600	700
Power cable (mm ²)	25	95	150	240	120 x 2	150 x 2	240 x 2
Fixation torque force (lb-in)	20	20	20	20	20	20	20

3 Operation & structure

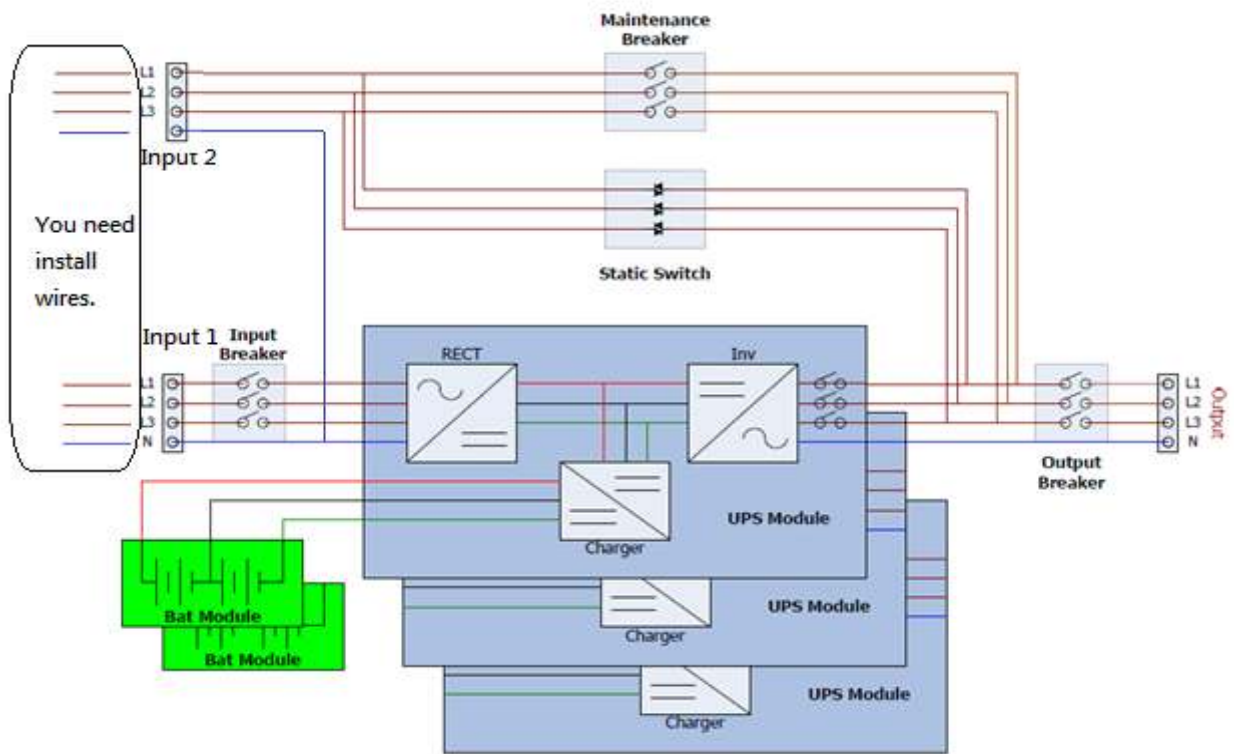


Figure 3-1: Wiring diagram for dual inputs

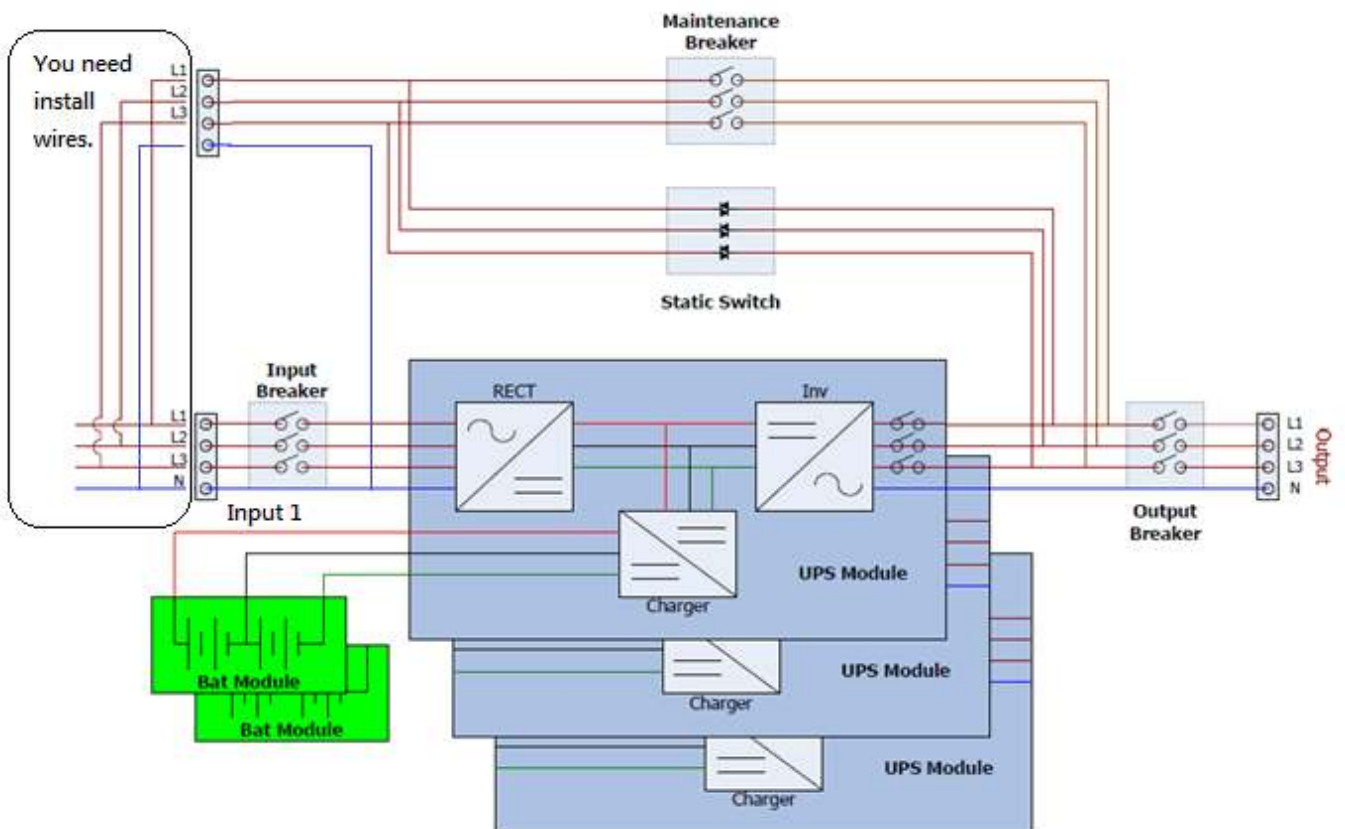


Figure 3-2: Wiring diagram for single input

3.1 Operation Mode

This module UPS is an on-line, double-conversion and reverse-transfer UPS that permits operation in the following modes:

- Standby Mode
- Line Mode
- Battery Mode
- Bypass Mode
- ECO Mode
- Shutdown Mode
- Cold Start mode
- Maintenance Bypass Mode (manual bypass)

3.1.1 Standby Mode

Upon connection of utility input power, the UPS is under Standby mode (if BYPASS enable setting is Disabled), and charger function will be active when battery voltage is detected.

3.1.2 Line Mode

The UPS inverter power modules continuously supply the critical AC load. The rectifier/charger derives power from the utility power and supplies DC power to the inverter while simultaneously FLOAT or BOOST charging its associated backup battery.

3.1.3 Battery Mode

Upon failure of the utility input power, the inverter power modules supply power to the critical AC load from battery. There is no interruption in power to the critical load upon failure. After utility power is restored, the "Line Mode" operation will continue automatically without any manual intervention.

3.1.4 Bypass Mode

If the inverter overload occurs under line mode, or if the inverter becomes unavailable for any reason, the static transfer switch will perform a transfer of the load from the inverter to the bypass source, with no interruption in power to the critical AC load. Should the inverter be asynchronous with the bypass, the static switch will perform a transfer of the load from the inverter to the bypass with power interruption to the load. This interruption is to avoid large current due to the unsynchronized AC sources.

3.1.5 Shutdown Mode

During Standby mode, if the failure of the utility power occurs, the UPS will enter into Shutdown mode and UPS will store the setting parameter.

3.1.6 Cold Start Mode

If there is no utility input power available and want UPS to start from battery mode, UPS can be started up from Cold start mode

3.1.7 Maintenance bypass Mode

A manual bypass switch is available to ensure continuity of supply to the critical load when the UPS becomes unavailable e.g. during a maintenance procedure. This manual bypass switch is fitted in all UPS modules and rated for full load of all modules.

3.2 Operation Instructions

Do not start the UPS until the installation is completed. The system should be commissioned by authorized personnel.

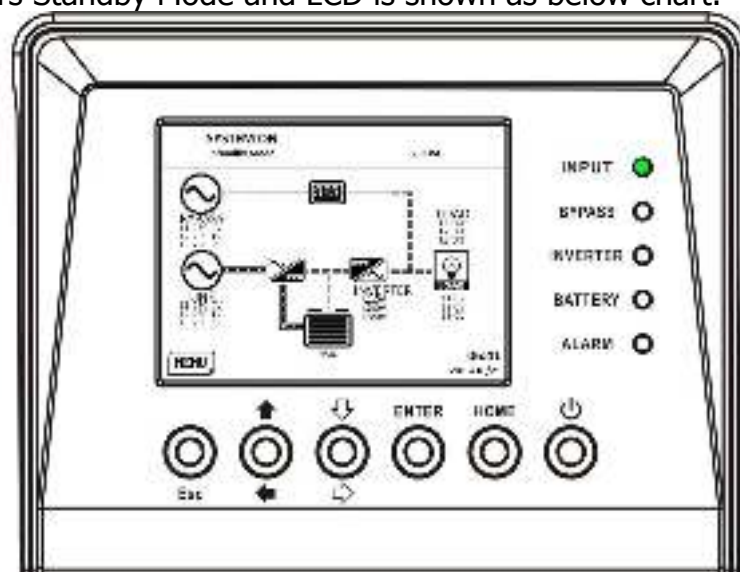
3.2.1 AC Startup

This procedure must be followed when turning on the UPS from a fully powered-down condition. The operating procedures are as follows:

Step 1: Connect the power supply cables and ensure the correct phase rotation. Open the external power switch. LCD panel will wake up.

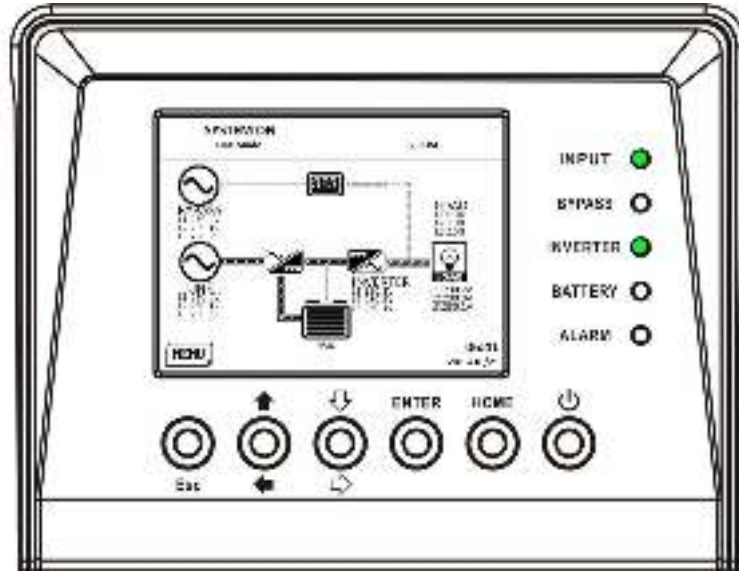
Step 2: Then, turn on the Q1 Main breaker to power up the power modules and remain the output circuit breakers (Q3) off.

Step 3: The UPS enters Standby Mode and LCD is shown as below chart.



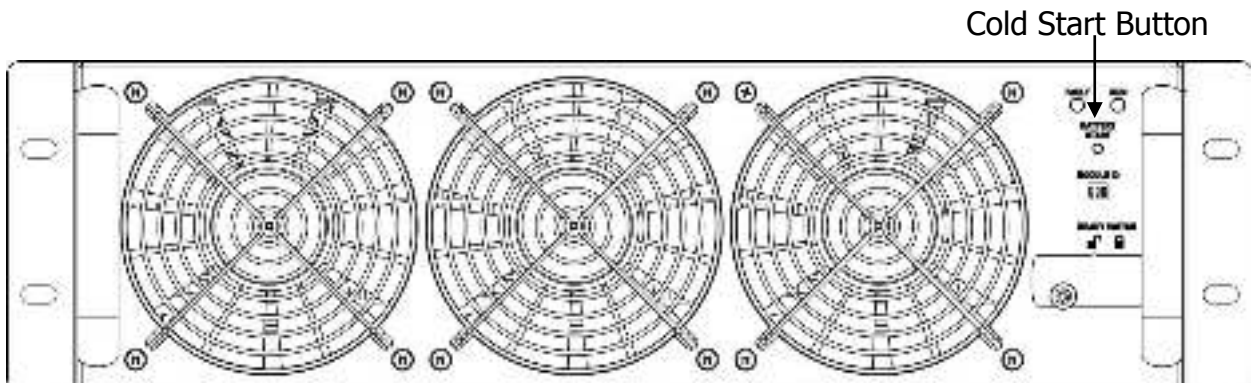
Step 4: Make sure no warning or fault event happened.

Step 5: Press Power ON/OFF button for two seconds to enter Line Mode as shown in below chart.

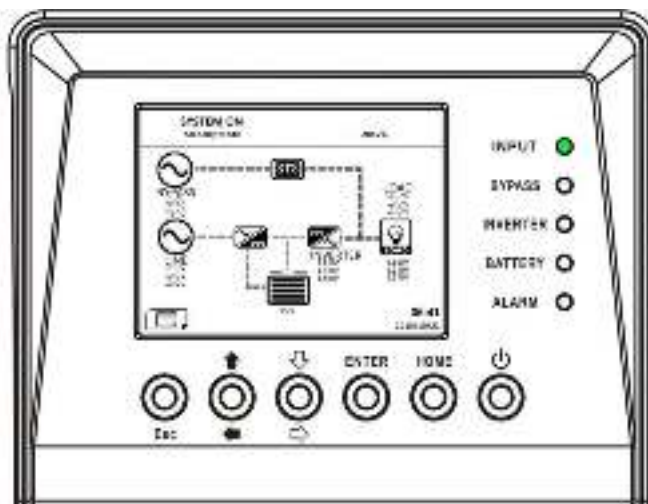


3.2.2 Cold Start Operation

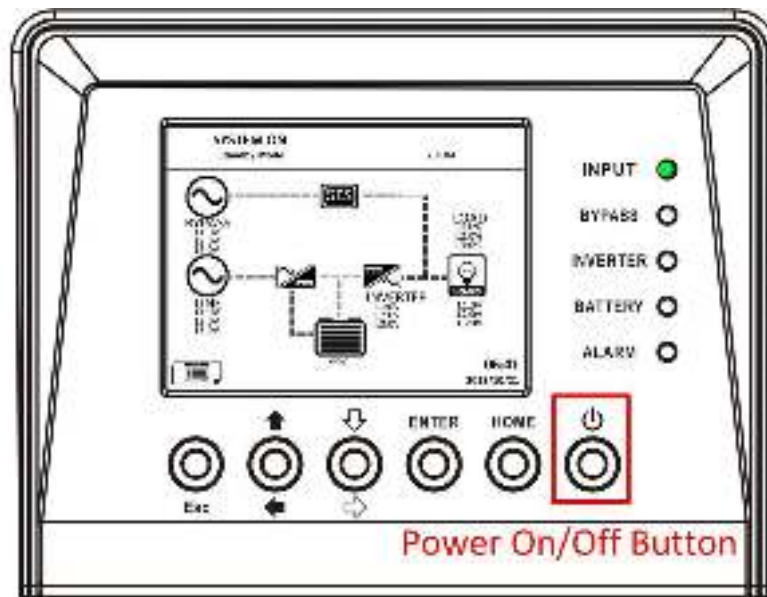
Step 1: Press "Cold Start" button as shown in below chart.



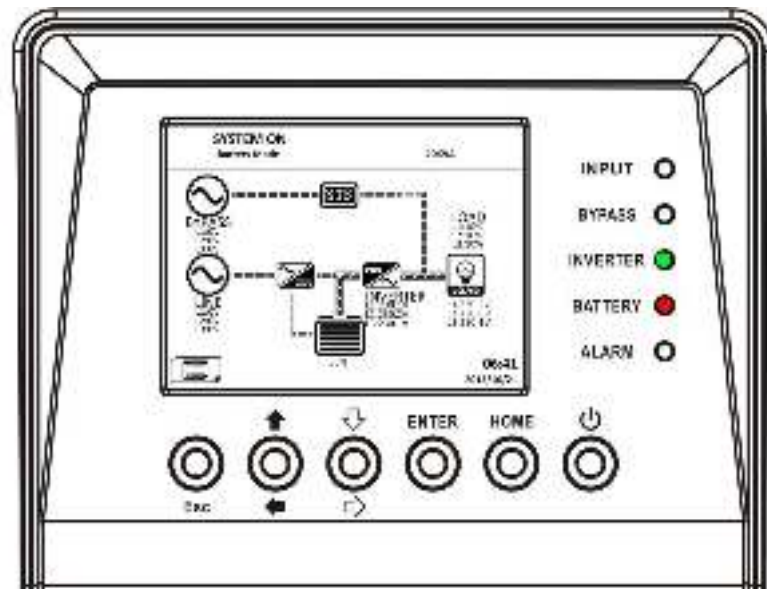
Step 2: After pressing Cold Start Button, UPS will enter Standby mode. Refer to below chart for LCD display.



Step 3: Before UPS enters shutdown mode, please press "Power On/Off" button for 2 second immediately as shown in below chart.



Step 4: Then, UPS will enter Battery Mode as shown below chart. Cold start procedure is complete.

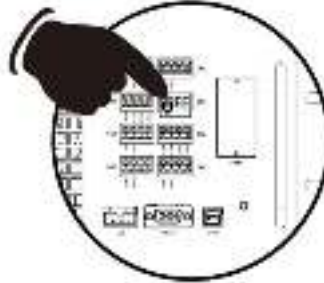


3.2.2 Maintenance Bypass Operation

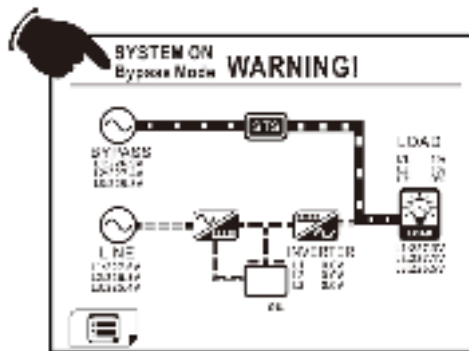
Follow the instruction to transfer Maintenance Bypass and UPS protection as below.

3.2.2.1 Transfer to maintenance bypass

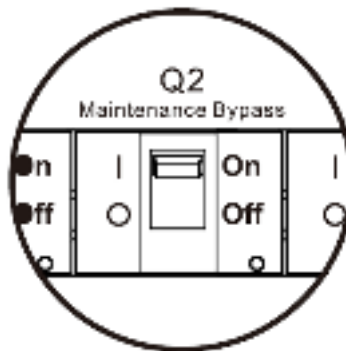
- 1) Remove connector from STS as shown in chart



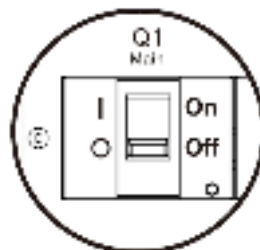
- 2) Make sure the UPS is operated in Bypass mode as shown in chart



- 3) Turn on Maintenance Bypass Breaker as shown in chart.



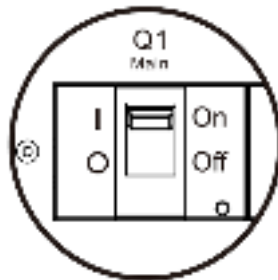
- 4) Turn off Main Breaker as shown in chart.



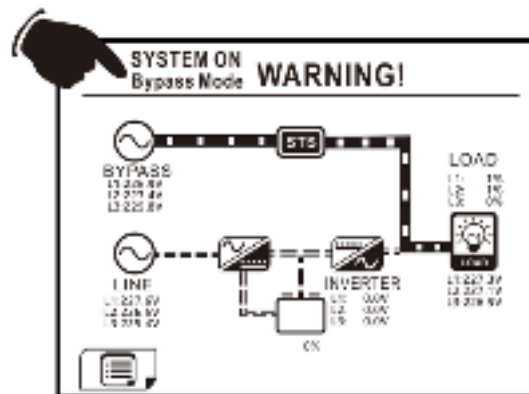
- 5) Now, it's safe to do UPS maintenance.

3.2.2.2 Transfer to UPS Protection

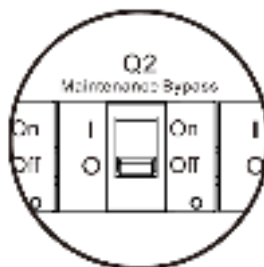
- 1) Make sure the UPS is maintained completely.
- 2) Turn on Main Breaker as shown in chart.



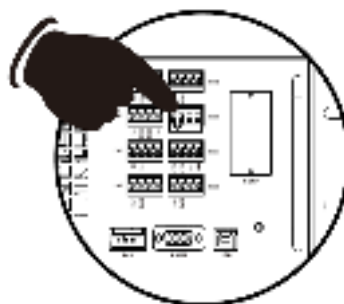
- 3) Please enter LCD SETUP MENU and chose "SYSTEM" to ensure that the bypass mode is enabled. Then, exit the SETUP menu and make sure the UPS is operated in bypass mode.



- 4) Turn off Maintenance Bypass Breaker as shown in chart



- 5) Put connector back to STS module as shown in chart.



4. Control Panel and Display Description

4.1 Introduction

This control panel and display description is located on the front door of the UPS. It is the USER control and monitoring of all measured parameters, UPS and battery status and alarms. The control panel and display description is divided into four functional areas: (1) LCD display, (2) LED indications, (3) Control keys, (4) Audio Alarm, as shown in Figure 4-1.

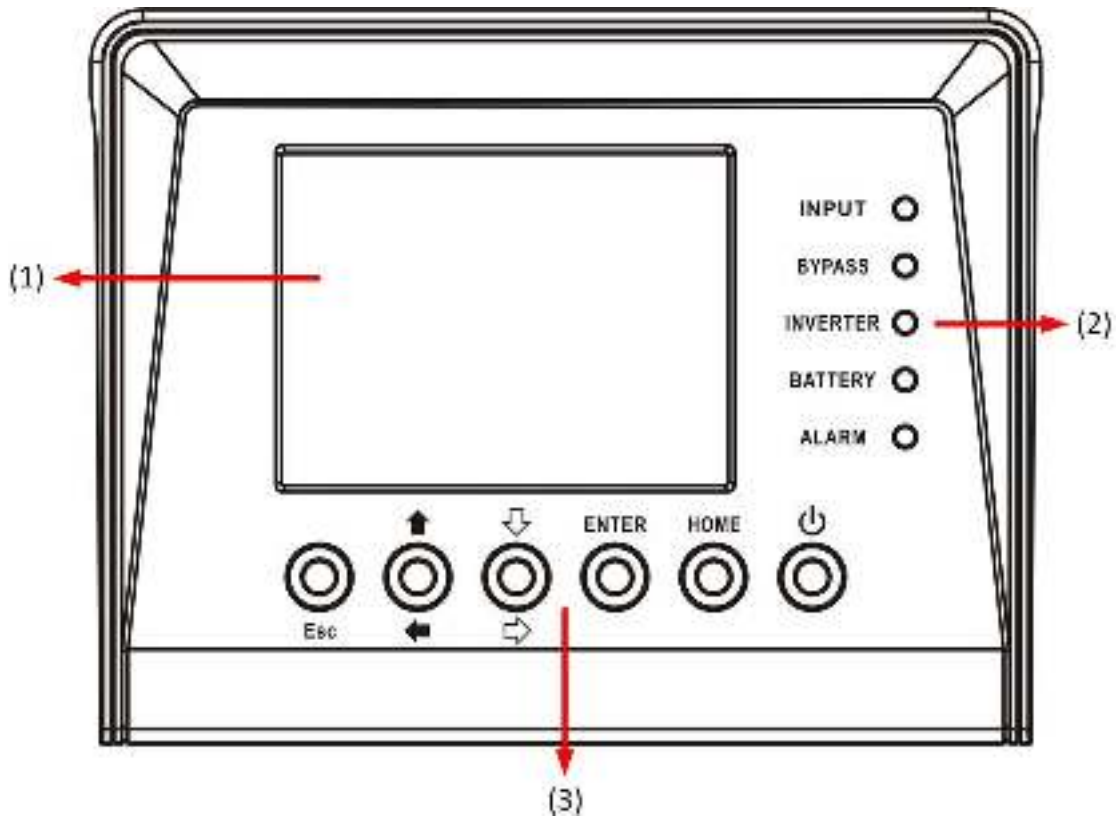


Figure 4-1 Control panel parts

- (1) LCD display: Graphic display and all measured parameters.
- (2) LED indications. Refer to table 4-1.
- (3) Control keys. Refer to table 4-2.

Table 4-1: LED indications

LED	Color	Status	Definition
INPUT	Green	On	Input source is normal.
		Flashing	Input source is abnormal.
		Off	No input source
BYPASS	Green	On	Load on Bypass.
		Flashing	Input source is abnormal.
		Off	Bypass not operating.
INVERTER	Green	On	Load on inverters.
		Off	Inverters not operating.
BATTERY	Yellow	On	Load on Battery.
		Flashing	Low battery
		Off	Battery converter is normal and battery is charging.
ALARM	Red	On	UPS fault.
		Flashing	UPS alarm.
		Off	Normal.

Table 4-2: Function key table

Control Key	Description
Esc	Return to previous screen or cursor displacement. When screen is in Main screen, it will enter setting menu by pressing ESC key.
Up(Left)	Key for menu page navigation, or digit modification.
Down(Right)	Key for menu page navigation, or digit modification.
Enter	Confirmation of commands, or cursor displacement.
Home	Return to Main screen.
Power On/Off	Turn on UPS or Turn off UPS. (hold 2-Sec)

(4) Audible Alarm: Table 4-3

Audio Type	Description
Power on/off	Buzzer sounds two seconds.
Battery mode	Buzzer sounds every 2 seconds.
Low battery	Buzzer sounds every half seconds.
UPS alarm	Buzzer sounds every 1 second.
UPS fault	Buzzer continuously sounding.

4.2 Screen Description

4.2.1 Start Screen

Upon UPS start, the UPS executes self-test. The initial screen displays and remains approximately 5 seconds as shown in Figure 4-2.

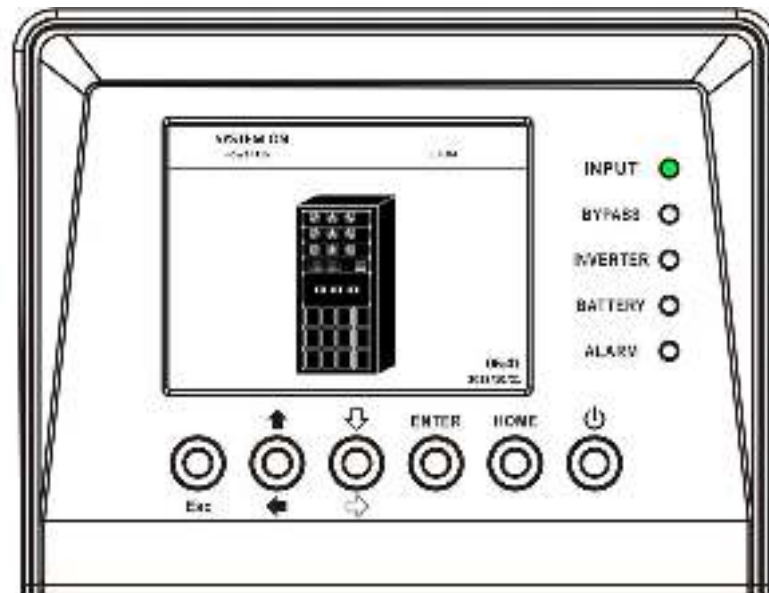


Figure 4-2 Initial screen

4.2.2 Main Screen

After initialization, the main screen will display as Figure 4-3. Main screen is divided into five parts.

- (1) UPS Mode: Current Operation Mode.
- (2) UPS Flow Chart: Current flow chart and measurement data.
- (3) Menu: Press ESC button to enter Menu screen.
- (4) UPS model name with power rating.
- (5) Date and Time.

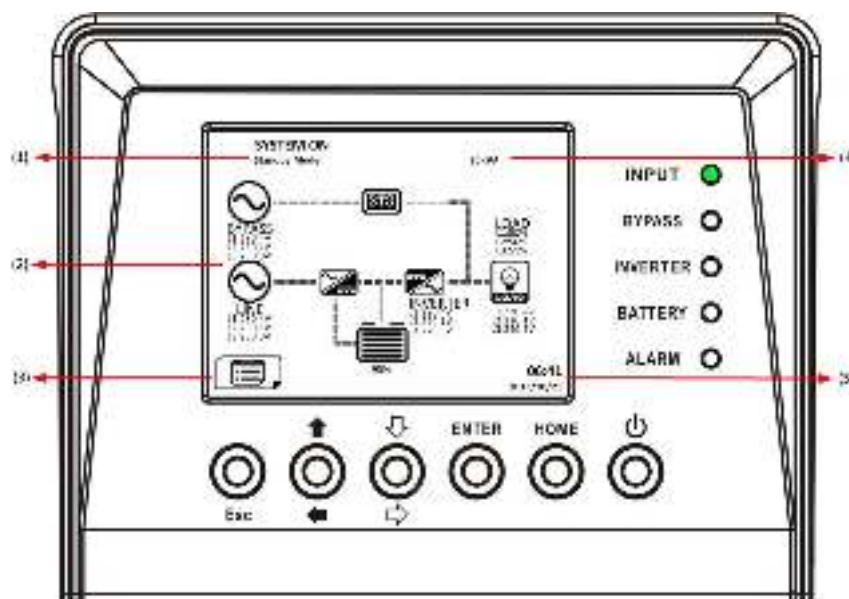


Figure 4-3 Main screen

4.2.3 Menu Screen

Use UP and DOWN buttons to choose between different menus, and Press ENTER to enter into the sub screen, as shown in Figure 4-4 and 4-5.

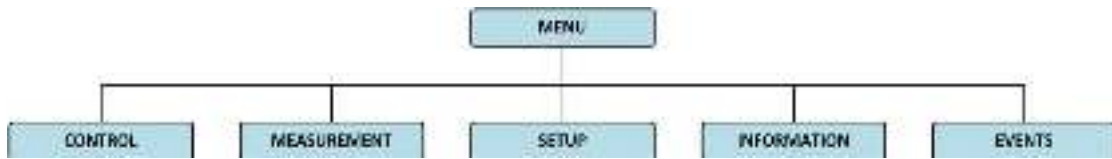


Figure 4-4 Menu tree

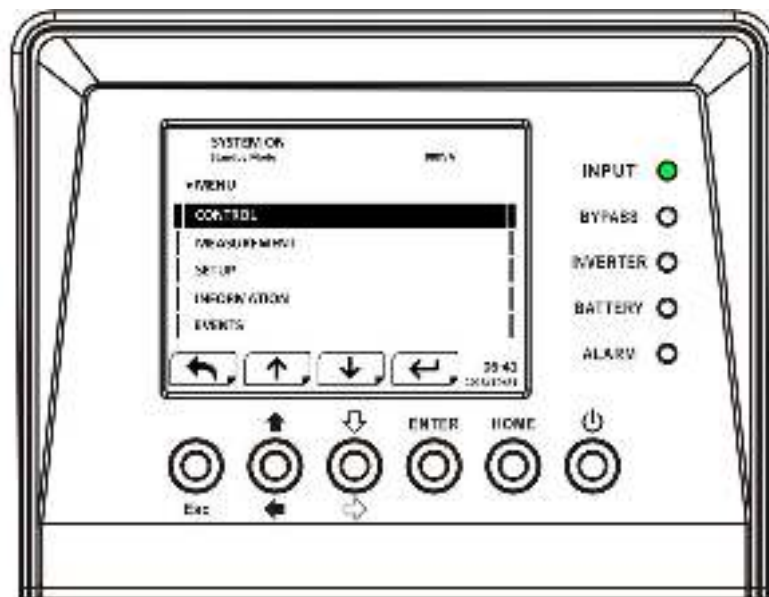


Figure 4-5 Menu screen

4.2.4 Control Screen

Use UP and DOWN buttons to choose CONTROL option, and press ENTER button to enter into the submenu, as shown in Figure 4-6 and 4-7.

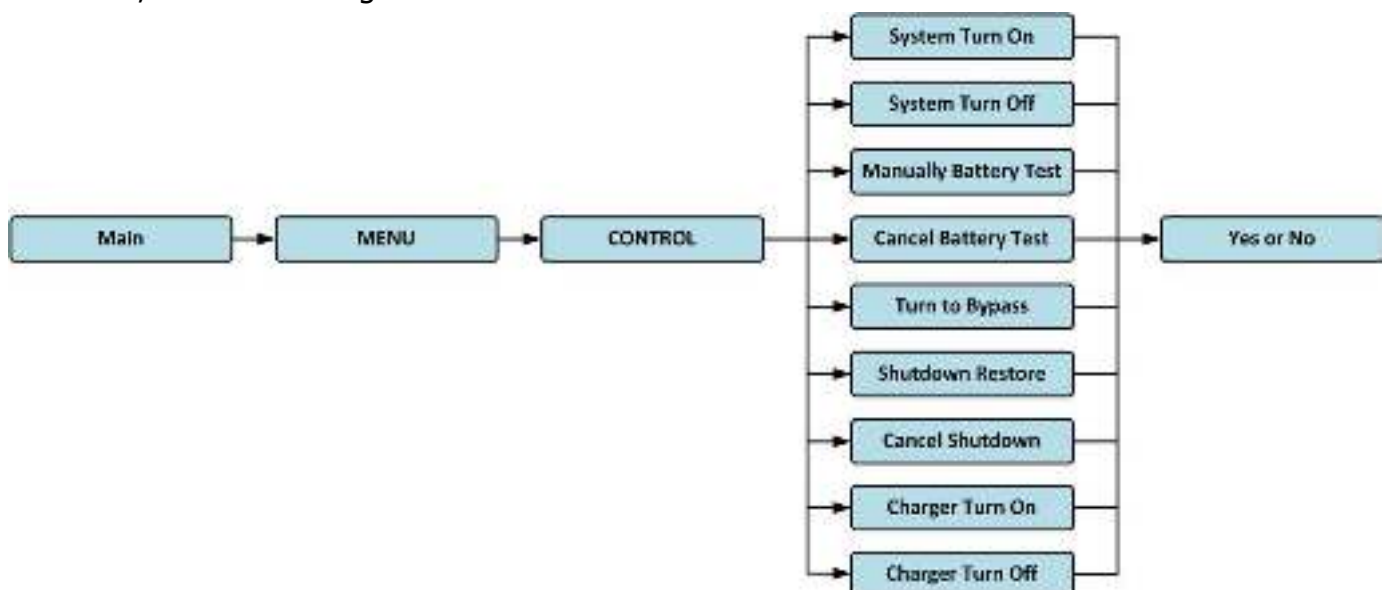


Figure 4-6 Control menu

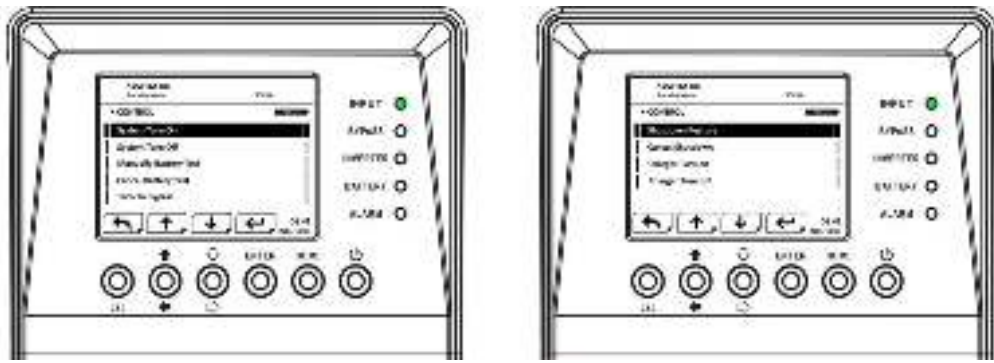


Figure 4-7 Control screen

Use LEFT and RIGHT buttons to choose YES or NO. Choose YES and press ENTER button to confirm command or choose NO to cancel command, as shown in Figure 4-8.

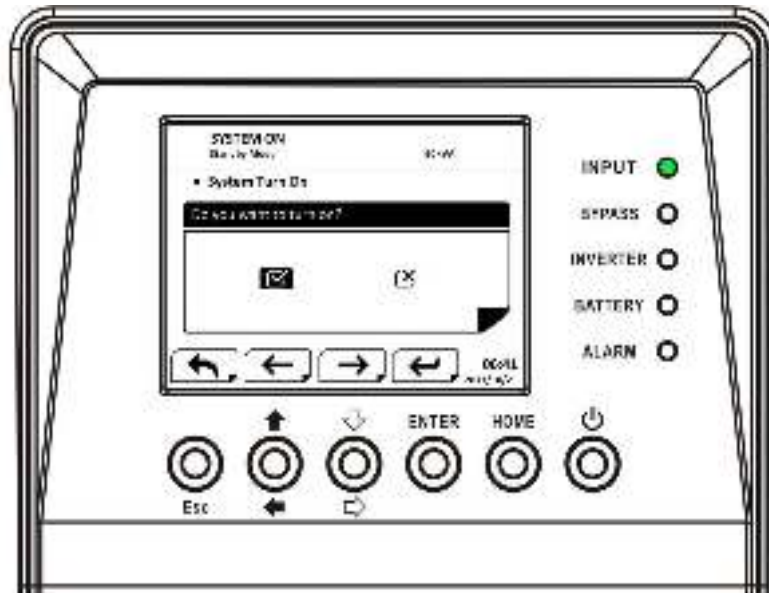


Figure 4-8 Yes or No screen

4.2.5 Measurement Screen

Use UP and DOWN buttons to choose MEASUREMENT option. Choose module ID number to measure Input, Output, Bypass, Load, and Battery of every module, as shown in Figure 4-9, 4-10 and Table 4-4.

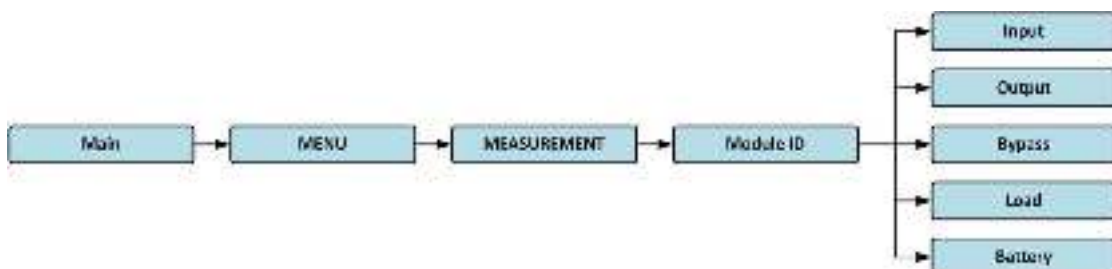


Figure 4-9 Measurement menu

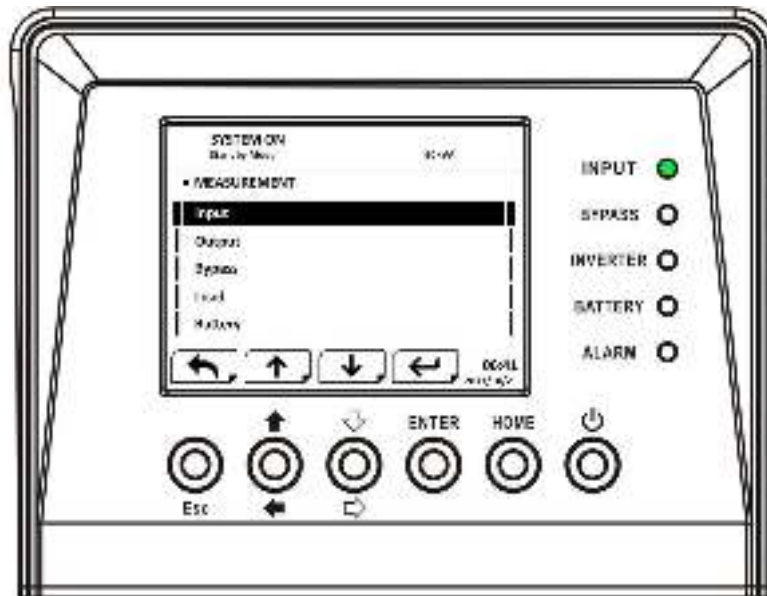


Figure 4-10 Measurement screen

Table 4-4

Menu	Item	Explanation
Input	L-N Voltage (V)	Input phase voltage (L1, L2, L3). Units 0.1V.
	Frequency (Hz)	Input Frequency (L1, L2, L3). Units 0.1Hz.
Output	L-N Voltage (V)	Output phase voltage (L1, L2, L3). Units 0.1V.
	L-N Current (A)	Output phase current (L1, L2, L3). Units 0.1A.
	Frequency (Hz)	Output Frequency (L1, L2, L3). Units 0.1Hz.
	Power Factor	Output Power Factor (L1, L2, L3).
Bypass	L-N Voltage (V)	Bypass phase voltage (L1, L2, L3). Units 0.1V.
	Frequency (Hz)	Bypass Frequency (L1, L2, L3). Units 0.1Hz.
	Power Factor	Bypass Power Factor (L1, L2, L3).
Load	Sout (KVA)	Apparent power. Units 0.1KVA.
	Pout (KW)	Active power. Units 0.1KW.
	Load Level (%)	The percentage of the UPS rating load. Units 1%.
Battery	Positive Voltage (V)	Battery Positive Voltage. Units 0.1V.
	Negative Voltage (V)	Battery Negative Voltage. Units 0.1V.
	Positive Current (A)	Battery Positive Current. Units 0.1A.
	Negative Current (A)	Battery Negative Current. Units 0.1A.
	Remain Time (Sec)	Battery run time remaining. Units 1sec.
	Capacity (%)	The percentage of the capacity of the battery. Units 1%.
	Test Result	Battery test result
	Charging Status	Battery charging status

4.2.6 Setup Screen

Use UP and DOWN buttons to choose SETUP options. It's required to enter password to access General, SYSTEM and BATTERY sub-menus, as shown in Figure 4-11, 4-12 and 4-13.

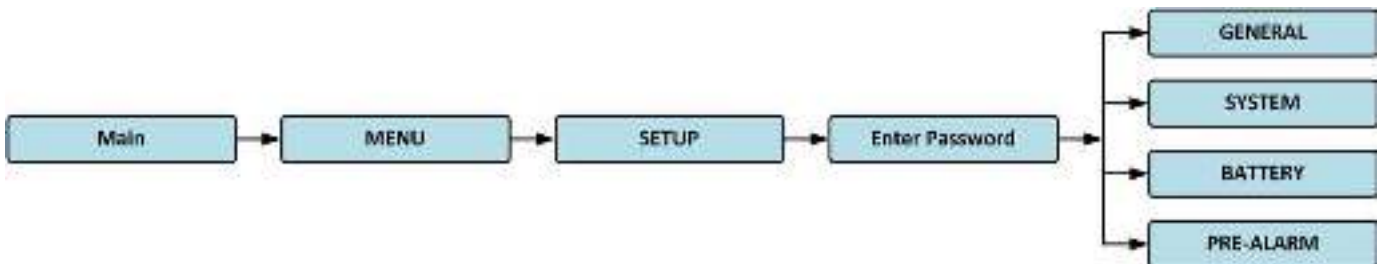


Figure 4-11 Setup menu

It's required to enter 4-digit password to enter SETUP menu. If incorrect password is entered, the LCD screen will ask for retry.

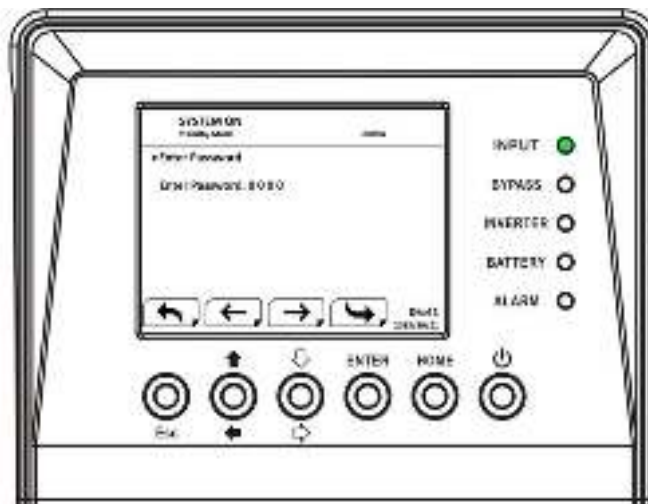


Figure 4-12 Enter password screen

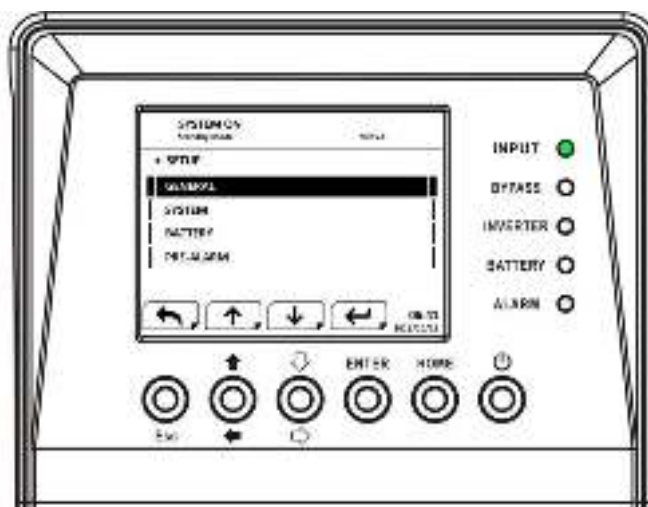


Figure 4-13 Setup screen

Table 4-5 All setting items in Setup Menu

UPS operation mode Setting item	Standby Mode	Bypass Mode	Line Mode	Battery Mode	Battery Test Mode	Fault Mode	Converter Mode	ECO Mode
Model Name	Y	Y	Y	Y	Y	Y	Y	Y
Language	Y	Y	Y	Y	Y	Y	Y	Y
TIME	Y	Y	Y	Y	Y	Y	Y	Y
Change Password	Y	Y	Y	Y	Y	Y	Y	Y
Baud Rate	Y	Y	Y	Y	Y	Y	Y	Y
Audible Alarm	Y	Y	Y	Y	Y	Y	Y	Y
Factory Reset	Y							
EEPROM Reset	Y							
EPO Function	Y							
Save Setting	Y	Y						
Turn On Password	Y	Y	Y	Y	Y	Y	Y	Y
Change Turn On Password	Y	Y	Y	Y	Y	Y	Y	Y
Output Voltage	Y	Y						
Bypass Voltage Range	Y	Y	Y	Y	Y	Y	Y	Y
Bypass Frequency Range	Y	Y						
Converter Mode	Y							
ECO Mode	Y	Y	Y					Y
Bypass Mode	Y	Y						
Auto-Restart	Y	Y	Y	Y	Y	Y	Y	Y
Cold Start	Y	Y	Y	Y	Y	Y	Y	Y
Battery Mode Delay Time	Y	Y	Y			Y	Y	Y
System Shutdown Time	Y	Y	Y	Y	Y	Y	Y	Y
System Restore Time	Y	Y	Y	Y	Y	Y	Y	Y
Redundancy	Y	Y	Y	Y	Y	Y	Y	Y
Power Rating Setting	Y							
Nominal Battery Voltage	Y	Y						
Battery Capacity in Ah	Y	Y	Y			Y	Y	Y

Maximum Charging Current	Y	Y						
Battery Low/Shutdown Setting	Y	Y	Y			Y	Y	Y
Periodic Battery Test	Y	Y	Y	Y	Y	Y	Y	Y
Battery Test Interval	Y	Y	Y	Y	Y	Y	Y	Y
Stop by Time	Y	Y	Y	Y		Y	Y	Y
Stop by Battery Voltage	Y	Y	Y	Y		Y	Y	Y
Stop by Battery Capacity	Y	Y	Y	Y		Y	Y	Y
Battery Age Alert	Y	Y	Y	Y	Y	Y	Y	Y
Pre-Alarm	Y	Y	Y	Y	Y	Y	Y	Y

Y means that this setting item can be set in this operation mode.

4.2.6.1 Setup-General Screen

Use UP and DOWN buttons to choose between different sub-menus, and press ENTER button to enter into the GENERAL setting screen, as shown in Figure 4-14. General setting can be set in any operating mode and Setup-General setting list is shown in table 4-6.

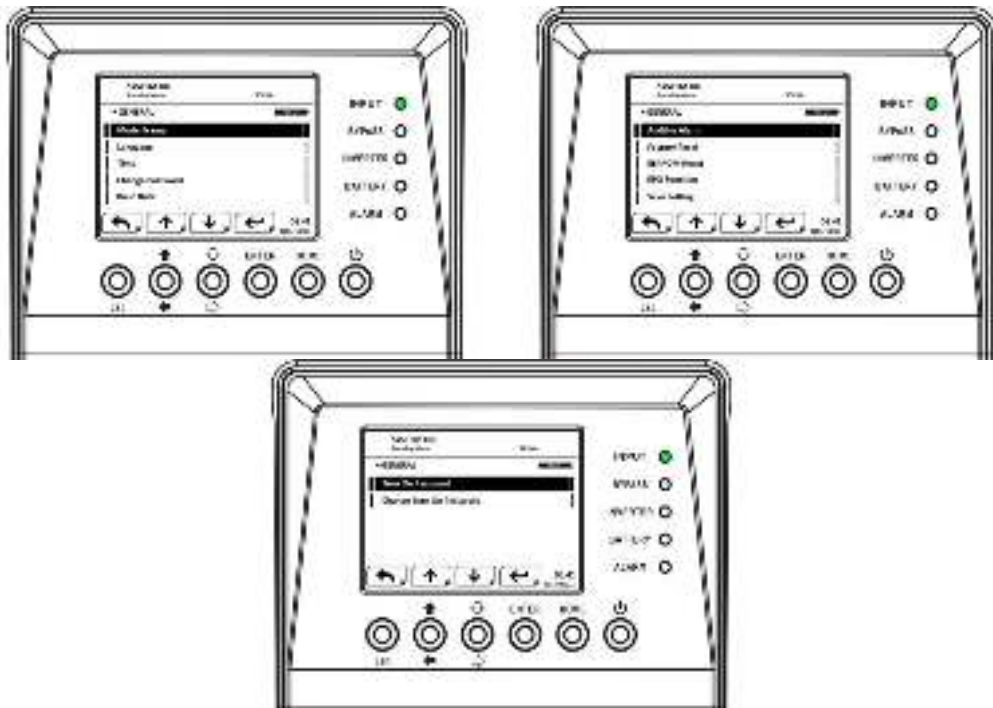


Figure 4-14 Setup-General screen

Use LEFT and RIGHT buttons to choose YES or NO. Choose YES and press ENTER button to confirm the setting change or choose NO to cancel the setting, as shown in Figure 4-15.

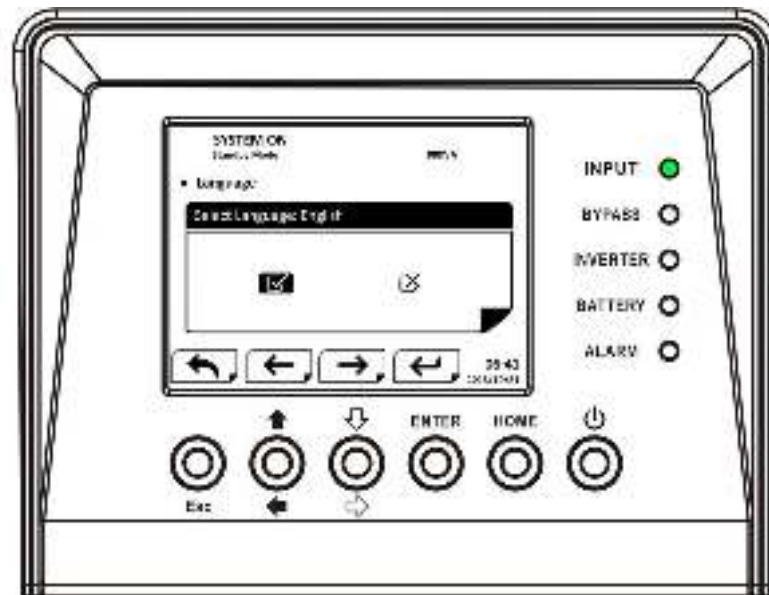


Figure 4-15 SETUP YES or NO screen

Table 4-6

Setting Item	Sub Item	Explanation
Model Name		Set UPS Name(xxxxxxxxxx)
Language	--	Provides 3 optional LCD languages (English, Traditional Chinese and Simplified Chinese)
TIME	Adjust Time	Set current date and time (yyyy / mm / dd hour : min : sec)
	System Installed Date	Set system installed date (yyyy / mm / dd)
	System Last Maintain Date	Set system latest maintenance date (yyyy / mm / dd)
	Battery Installed Date	Set battery installed date (yyyy / mm / dd)
	Battery Last Maintain Date	Set battery latest maintenance date (yyyy / mm / dd)
Change Password	--	Set New Password.
Baud Rate	--	Set COM Port0 Baud Rate(2400, 4800, 9600)
		Set COM Port1 Baud Rate(2400, 4800, 9600)
Audible Alarm	--	Set Audible Alarm "Disable" or "Enable"
Factory Reset	--	Restore to factory default setting
EEPROM Reset	--	Set EEPROM default
EPO Function	--	Set EPO "Normal Close Active" or "Normal Open Active"

Save Setting	--	Save EEPROM
Turn On Password	--	"Disable" or "Enable" password permission for UPS turn on.
Change Turn On Password	--	Change "Turn On Password".

4.2.6.2 Setup-System Screen

Use UP and DOWN buttons to browse different menus and press ENTER button to enter into the SYSTEM setting screen, as shown in Figure 4-16. System setting can be set only when UPS is operated in certain mode. Please check setting item availability table 4-5 for the details. If it's not set up under specific mode, the warning screen will appear. Refer to figure 4-17 and Setup-System setting list is shown in table 4-7.

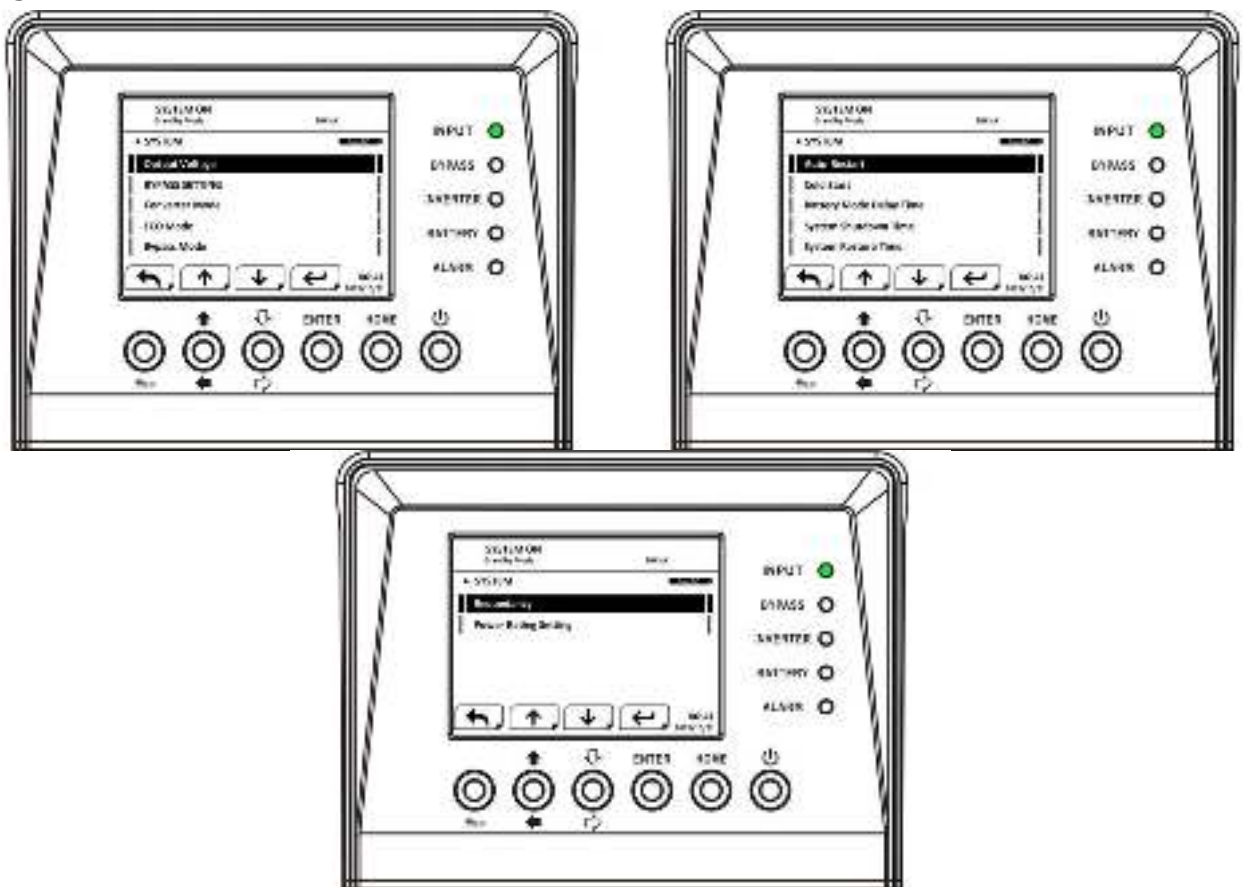


Figure 4-16 Setup-System screen

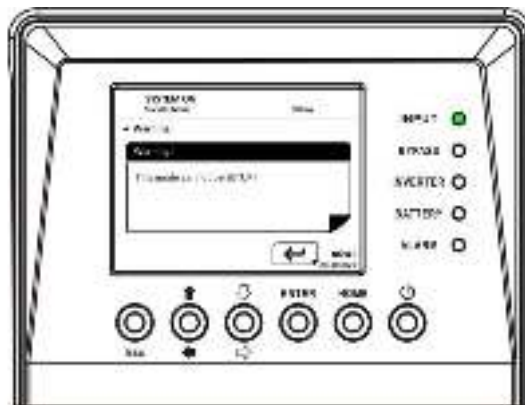


Figure 4-17 Warning screen

Table 4-7

Setting Item	Sub Item	Explanation
Output Voltage	--	Set output voltage (220Vac, 230Vac, 240Vac)
BYPASS SETTING	Bypass Voltage Range	Set bypass voltage range: upper limit (+10%, +15%, +20%) and lower limit (-10%, -20%, -30%)
	Bypass Frequency Range	Set bypass Frequency range: upper limit (+1Hz, +2Hz, +4Hz) and lower limit (-1Hz, -2Hz, -4Hz)
Converter Mode	--	Set converter mode "Disable" or "Enable"
ECO Mode	--	Set ECO mode "Disable" or "Enable"
Bypass Mode	--	Set bypass mode "Disable" or "Enable"
Auto-Restart	--	Set auto-restart "Disable" or "Enable". After "Enable" is set up, once UPS shutdown occurs due to low battery and then utility restores, the UPS will return to line mode.
Cold Start	--	Set cold start "Disable" or "Enable". After "Enable" is set, the UPS can be turned on without utility connection by pressing Battery Start Button. Refer to cold start operation for the details.
Battery Mode Delay Time	--	Set system shutdown delay time in battery mode (0~9990sec)
System Shutdown Time	--	Set system shutdown time (0.2~99min)
System Restore Time	--	Set system restore time (0~9999min)
Redundancy	--	Set total power and redundancy
Power Rating Setting		Set Power Rating "20KVA" or "30KVA" for each power module. If setting is not corresponding to power capacity of power module, it will show error message.

4.2.6.3 Setup-Battery Screen

Use UP and DOWN buttons to switch different sub-menus. Press ENTER button to enter into the BATTERY setting screen, as shown in Figure 4-18. Battery setting can be set only when UPS is operated in standby mode. If it's not in standby mode, the warning screen will appear as shown in Figure 4-17. See Battery-System setting list in table 4-8.

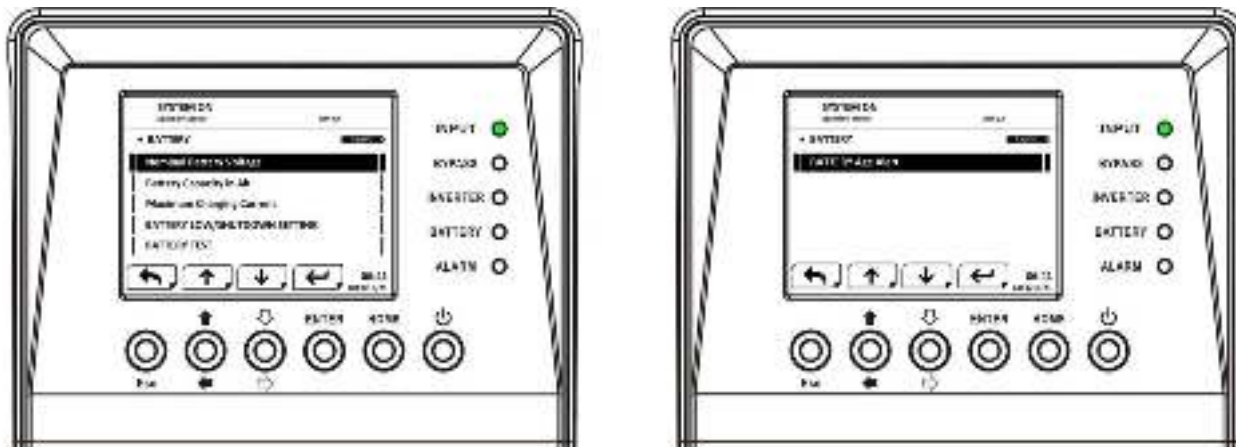


Figure 4-18 Setup-Battery Screen

Table 4-8

Setting Item	Sub Item	Explanation
Nominal Battery Voltage	--	Set battery nominal voltage(16x12V, 18x12V, 20x12V)
Battery Capacity in Ah	--	Set battery capacity. (0~999)
Maximum Charging Current	--	Set battery maximum charging current (1~128A)
BATTERY LOW/SHUTDOWN SETTING	Battery Low Voltage	Set battery low voltage (10.5~11.5V)x(battery Number)
	Battery Low Capacity	Set battery low capacity (20~50%)
	Battery Shutdown Voltage	Set battery voltage point for system shutdown in battery mode (10.0~11V) x (battery Number)
BATTERY TEST	Periodic Battery Test	Set periodic battery test "Disable" or "Enable"
	Battery Test Interval	Set battery test interval (7~99 Days)
	Stop by Time	Set testing time for battery test (10~1000sec)
	Stop by Battery Voltage	Set stop battery voltage in battery test (11~12V) x (battery Number)
	Stop by Battery Capacity	Set battery capacity to stop battery-testing. (20~50%)
Battery Age Alert	Battery Age Alert (Months)	Set battery age for replacement. (12~60Months)

4.2.6.4 Pre-Alarm Screen

Use UP and DOWN buttons to switch different sub-menus. Press ENTER button to enter into the Pre-Alarm setting screen, as shown in Figure 4-19. Pre-Alarm setting can be set in any operation mode. See Setup-Pre-Alarm setting list in table 4-9.

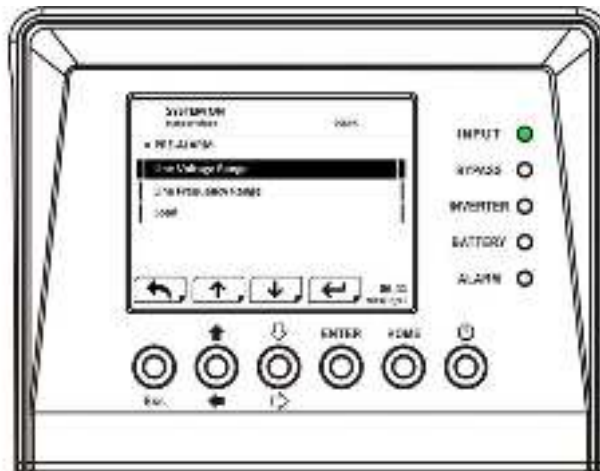


Figure 4-19 Setup-Pre-Alarm screen

Table 4-9

Setting Item	Sub Item	Explanation
Line Voltage Range	--	Set line voltage range: upper limit (+5%, +10%, +15%, +20%) and lower limit (-5%, -10%, -15%, -20%)
Line Frequency Range	--	Set line frequency range: upper limit (+1Hz, +2Hz, +3Hz, +4Hz) and lower limit (-1Hz, -2Hz, -3Hz, -4Hz)
Load	Overload	Set UPS Overload percentage (40~100%)
	Load Unbalance	Set UPS output load unbalance percentage (20~100%)

4.2.7 Information Screen

In this Screen you can check the UPS configuration of the unit, and INFORMATION divided into Identification, System and Battery, as shown in Figure 4-20, 4-21, 4-22, 4-23 and 4-24.

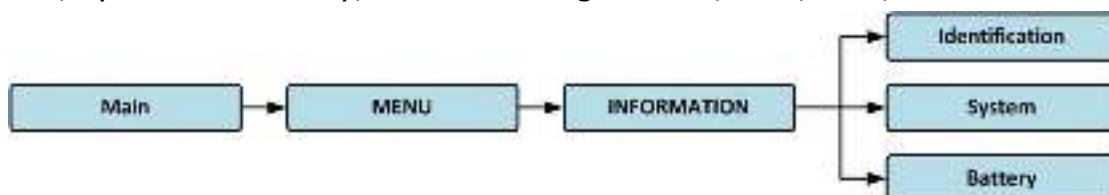


Figure 4-20 Information menu

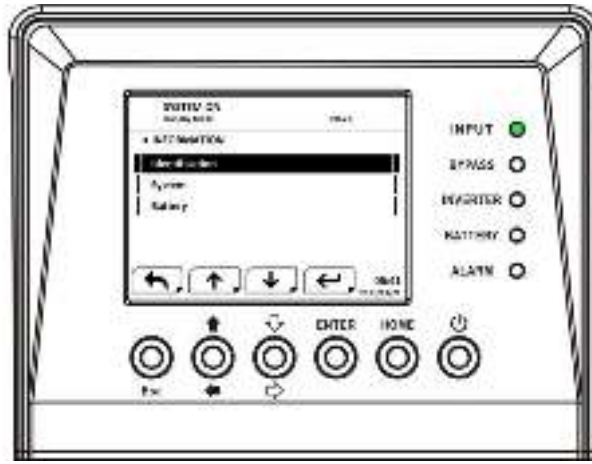


Figure 4-21 Information screen

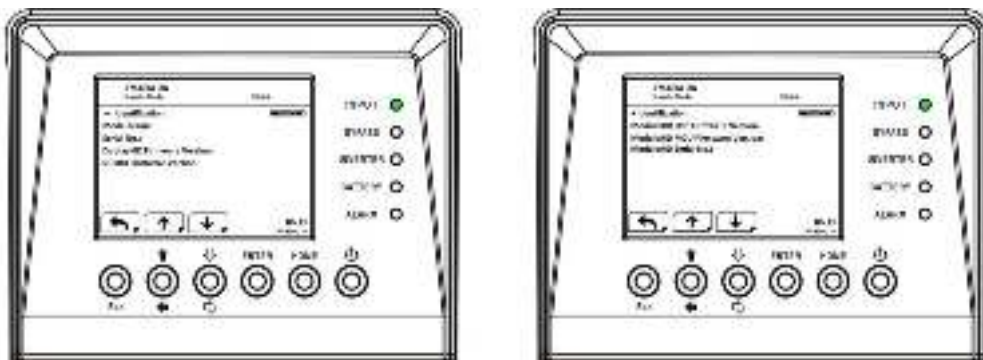


Figure 4-22 Information-Identification screen

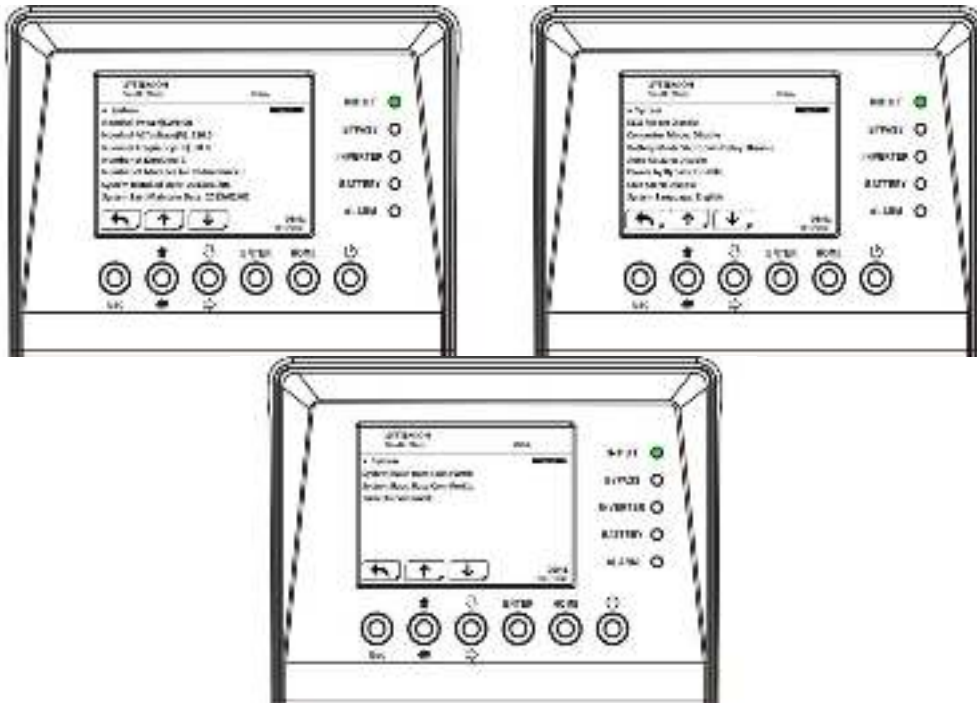


Figure 4-23 Information-System screen

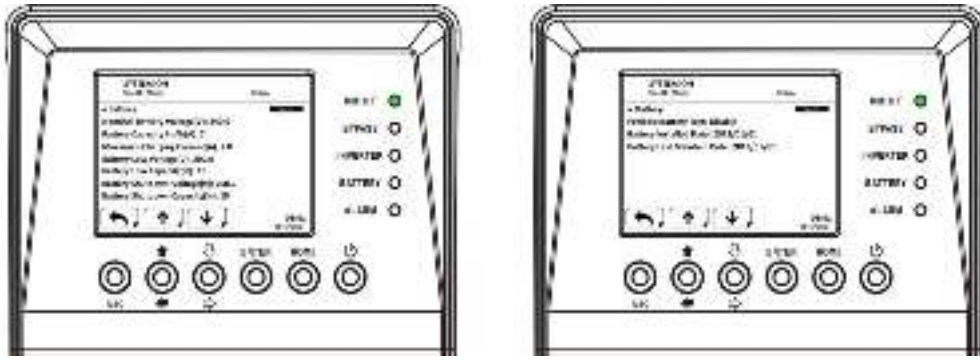


Figure 4-24 Information-Battery screen

4.2.8 Events Screen

When event occurs, you will see flashed warning text in the Main Screen as shown in Figure 4-25. Besides, you also can enter the EVENTS Menu to check the latest event lists and history events as shown in Figure 4-26 and 4-27.

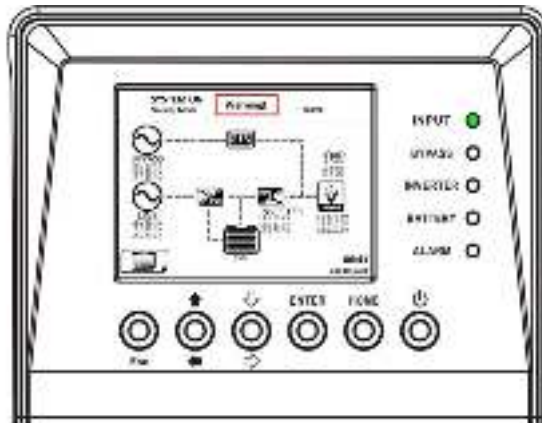


Figure 4-25 Alarm warning screen

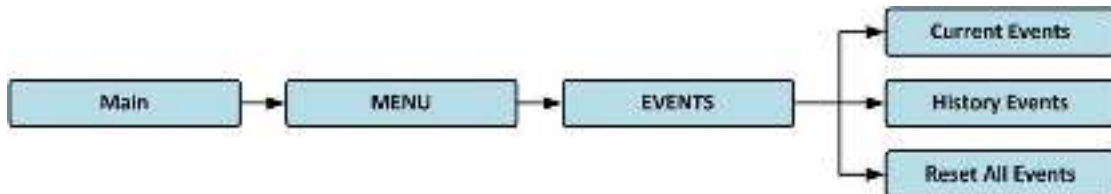


Figure 4-26 Events menu

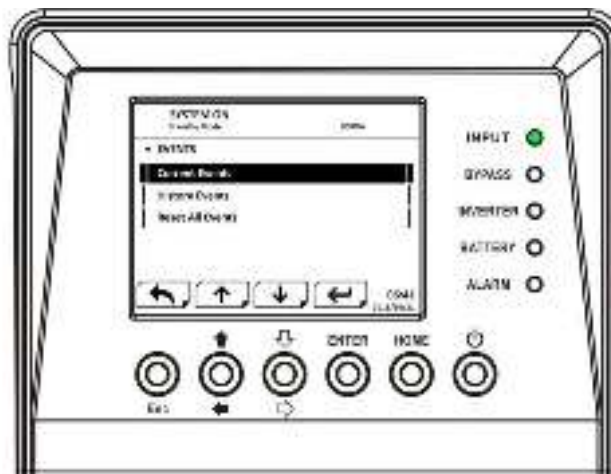


Figure 4-27 Events screen

4.2.8.1 Current Events

When event occurs, it displays Module ID and alarm code in Current Events screen. It can save up to 50 events in current events. Only 4 events can list in one page. Therefore, if it exceeds more than four, you have to press UP or DOWN button to read other event as shown in Figure 4-28.

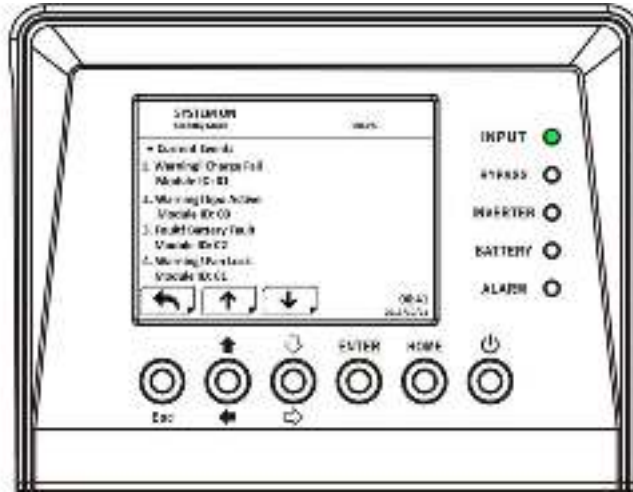


Figure 4-28 Current Events screen

4.2.8.2 History Events

It saved detailed information in history events. When warning occurs, it will display alarm code, alarm time and Module ID. When fault event occurs, it will display alarm code, alarm time, Module ID and data 1~2. Refer to Figure 4-29 for display screen.

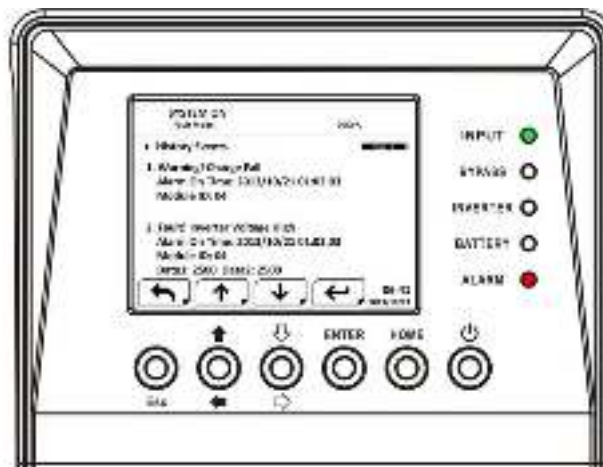


Figure 4-29 History Events screen

4.2.8.3 Reset All Events

It's required to enter 4-digit password to enter Reset All Events screen as shown in Figure 4-30. Then, use LEFT and RIGHT buttons to choose YES or NO. Choose YES and press ENTER button to reset all events or choose NO to cancel this action as shown in Figure 4-31.

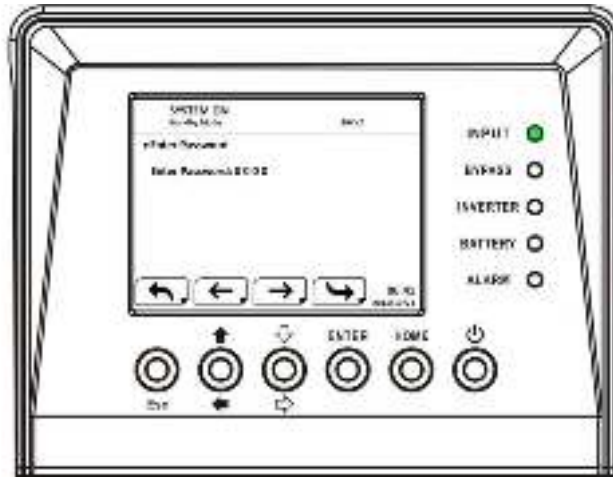


Figure 4-30 Reset All Events screen

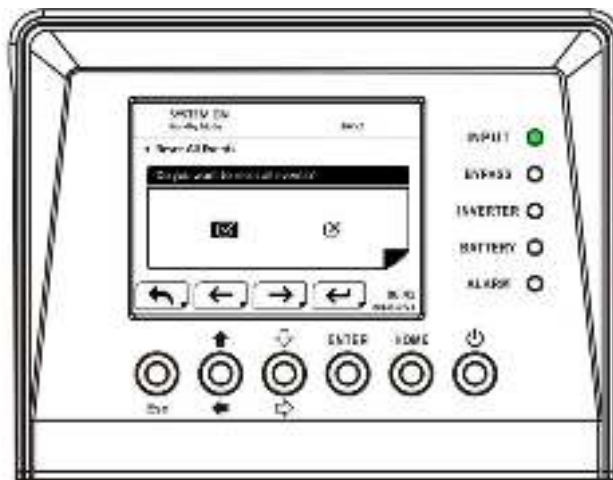


Figure 4-31 Reset All Events screen

4.3 Alarm List

In Table 4-10, it provides the complete list of UPS alarm messages.

Table 4-10

Representation in display LCD	Explanation
Fault! Bus Over Voltage	DC bus voltage is too high
Fault! Bus Under Voltage	DC bus voltage is too low
Fault! Bus Voltage Unbalance	DC bus voltage is not balanced
Fault! Bus Short	DC bus is short
Fault! Bus Soft Start Time Out	The rectifiers could not start due to low DC bus voltage within specified duration
Fault! Inverter Soft Start Time Out	Inverter bus voltage cannot reach desired voltage within specified duration
Fault! Inverter Voltage Over	Inverter Voltage over (Peak Value)
Fault! Inverter Voltage High	Inverter Voltage is too high
Fault! Inverter Voltage Low	Inverter Voltage is too Low
Fault! R Inverter Voltage Short	R phase inverter Output is shorted
Fault! S Inverter Voltage Short	S phase inverter Output is shorted

Fault! T Inverter Voltage Short	T phase inverter Output is shorted
Fault! RS Inverter Voltage Short	R-S inverter Output is shorted
Fault! ST Inverter Voltage Short	S-T inverter Output is shorted
Fault! TR Inverter Voltage Short	T-R inverter Output is shorted
Fault! Inverter R Negative Power	R phase inverter Output Negative Power over range
Fault! Inverter S Negative Power	S phase inverter Output Negative Power over range
Fault! Inverter T Negative Power	T phase inverter Output Negative Power over range
Fault! Over Load Fault	Heavy overload causes UPS fault.
Fault! Battery Fault	Battery reverse
Fault! Over Temperature	Make sure adequate space is allowed for air vents and the fan is working
Fault! CAN Fault	CAN communication fault
Fault! TRIG0 Fault	Synchronized trigger signal fault
Fault! Relay Fault	Inverter relay fault
Fault! Line SCR Fail	Line SCR short circuit fault
Fault! EEPROM Fault	EEPROM operation error
Fault! Parallel Cable Loosen Fault	As stated.
Fault! DSP MCU Stop Communicate	As stated.
Fault! Bypass Temperature Fault	As stated
Fault! Bypass SCR Fault	As stated.
Line Fail	Utility lost or abnormal
Line Restore	Utility recovered to normal
Warning! EPO Active	Check the EPO connector
Warning! Over Load Fail	The load devices are demanding more power than the UPS can supply. Line mode will transfer to Bypass mode.
Warning! Communicate CAN Fail	CAN communication error
Warning! Over Load	In Line mode, the load devices are demanding more power than the UPS can supply.
Warning! Battery Open	Battery not connected
Warning! Battery voltage High	Battery voltage is too High
Warning! Module Un-Lock	As stated.
Warning! Turn On Abnormal	As stated.
Warning! Charge Fail	As stated.
Warning! EEPROM Fail	EEPROM operation error
Warning! Fan Lock	As stated.

Warning! Line Phase Error	As stated.
Warning! Bypass Phase Error	As stated.
Warning! N Loss	Neutral loss
Warning! Internal Initial Fail	As stated.
Warning! Comm Syn Signal Fail	Communicate Synchronization Signal Fail
Warning! Comm TRIG0 Fail	Communicate Trigger signal fault
Warning! Redundancy Set Fail	As stated.
Warning! Parallel Sys Config Wrong	Parallel System Configure error
Warning! Maintenance Bypass	Enter maintenance
Warning! Battery Age Alert	Battery Life expiration
Warning! Parallel Rack Cable Loosen	As stated.
Warning! Parallel Rack Config Wrong	Parallel Rack Configure error
Warning! Battery Voltage Low	Battery voltage is too low.
Warning! ID Conflict	Power module ID conflict.
Pre-Alarm! Line Voltage Fail	Line voltage over range
Pre-Alarm! Line Voltage Normal	Line voltage recovered to normal
Pre-Alarm! Line Frequency Unstable	Line frequency over range
Pre-Alarm! Line Frequency Normal	Line frequency recovered to normal
Pre-Alarm! Over Load	Output Load over range
Pre-Alarm! Load Normal	Output Load recovered to normal
Pre-Alarm! Load Unbalance	Output Load unbalance

5. Interface and Communication

As shown in figure 5-1, the Static Transfer Switch (STS) Module includes dry contact Port (X1~X8), and communication port (RS232 Port, USB port, SNMP Card Port) on the front panel.

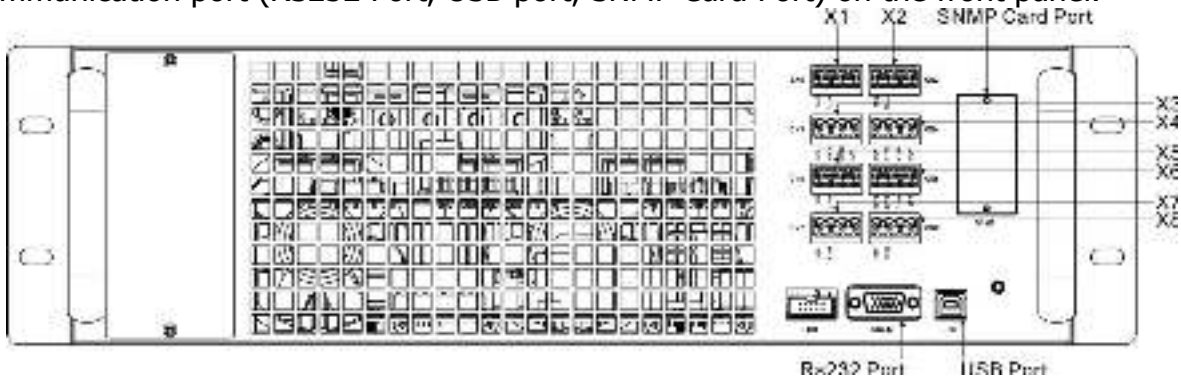


Figure 5-1 Dry contact ports and communication ports

Dry Contact No.	Function
X1	Remote EPO input port
X2	Reserve for system use
X3	BCB Port (Battery Circuit Breaker) – reserved function
X4	Maintenance Bypass Switch State Port
X5	Internal Output Switch State Port – reserved function – reserved function
X6	Battery Cabinet Temperature Detection Port – reserved function
X7	Bypass back feed Control Port – reserved function
X8	Battery breaker Control Port – reserved function

5.1 Remote EPO Input Port

The UPS has an Emergency Power off (EPO) Function that can be operated by a remote contact provide by user. Users can set the logic (N.C or N.O) of this EPO Function through LCD panel.

X1 is the remote EPO input port. The port is shown in Figure 5-2 and described in Table 5-1.

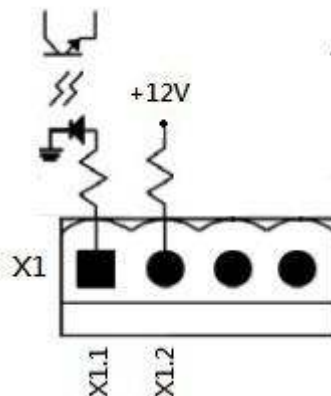


Figure 5-2 Remote EPO input port

Table 5-1 Description of remote EPO port

EPO Logic Setting	Position	Description
N.C	X1.1 & X1.2	EPO activated when Opened X1.1 & X1.2
N.O	X1.1 & X1.2	EPO activated when Shorted X1.1 & X1.2

If EPO Logic setting is Normal Closed (N.C), EPO is triggered when pins 1 and 2 of X1 are opened. Otherwise, EPO Logic setting is Normal Opened (N.O). EPO is triggered when pins 1 and 2 of X1 are opened.

Note:

1. EPO action shuts down the rectifiers, inverters and static transfer switch. But it does not internally disconnect the input power supply.
2. The default setting of the EPO function logic is Normal Opened (N.O).

5.2 BCB Port

This function is reserved.

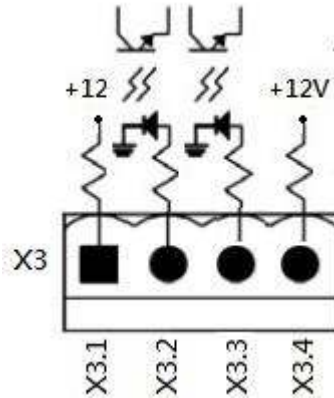


Figure 5-3 BCB port

Table 5-2 Description of BCB port

Name	Position	Description
BCB CONNECTED Pin1	X3.1	Reserved
BCB CONNECTED Pin 2	X3.2	Reserved
BCB STATUS Pin 3	X3.3	Reserved
BCB STATUS Pin 4	X3.4	Reserved

5.3 Maintenance Bypass Switch State Port

X4 is the maintenance bypass switch and External maintenance bypass switch state port. The port is shown in Figure 5-4 and described in Table 5-3. (This function is reserved)

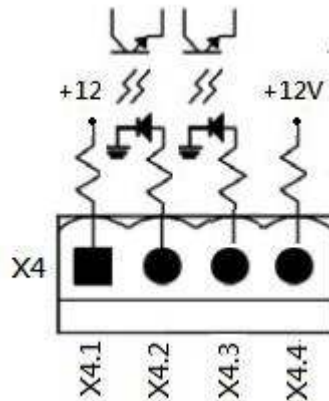


Figure 5-4 Maintenance Bypass Switch State port

Table 5-3 Description of Maintenance Bypass Switch State port

Name	Position	Description
Maintain Bypass Pin1	X4.1	Maintenance bypass switch state
Maintain Bypass Pin 2	X4.2	Maintenance bypass switch state
Ext. Maintain Bypass Pin 3	X4.3	Ext. Maintenance bypass switch state
Ext. Maintain Bypass Pin 4	X4.4	Ext. Maintenance bypass switch state

5.4 Internal Output Switch State Port

X5 is the internal output switch state port. The port is shown in Figure 5-5 and described in Table 5-4. (This function is reserved)

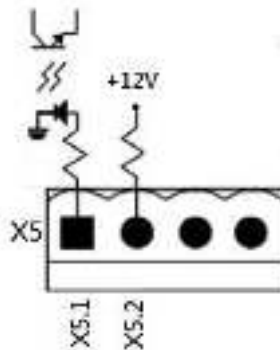


Figure 5-5 Internal Output Switch State Port

Table 5-4 Description of Internal Output Switch State Port

Name	Position	Description
Internal Output Pin1	X5.1	Internal Output switch state (Reserved)
Internal Output Pin 2	X5.2	Internal Output switch state (Reserved)

5.5 Battery Cabinet Temperature Detection Port

The UPS has battery cabinet temperature detection function. UPS can through the external battery cabinet temperature detection board to receive battery cabinet temperature. Communication between the Ups and Battery temperature detection board was by I2C communication protocol. X6 is the battery cabinet temperature detection port. The port is shown in Figure 5-6 and described in Table 5-5.

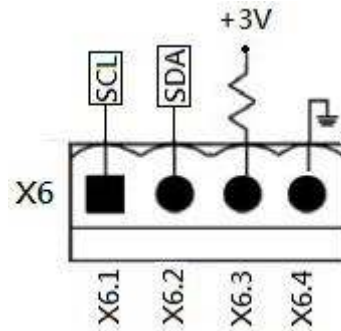


Figure 5-6 Battery Cabinet Temperature Detection Port

Table 5-5 Description of Battery Cabinet Temperature Detection Port

Name	Position	Description
SCL	X6.1	I ² C communication SCL Signal
SDA	X6.2	I ² C communication SDA Signal
+3.0V	X6.3	3V
Power GND	X6.4	GND

5.6 Bypass back feed Control Port

This function is reserved.

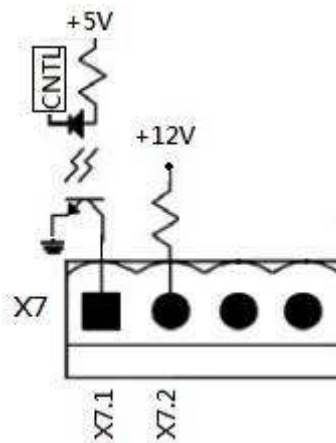


Figure 5-7 Bypass back feed Control Port

Table 5-6 Description of Bypass back feed Control Port

Name	Position	Description
Pin1	X7.1	Reserved
Pin 2	X7.2	Reserved

5.7 Battery breaker Control Port

This function is reserved.

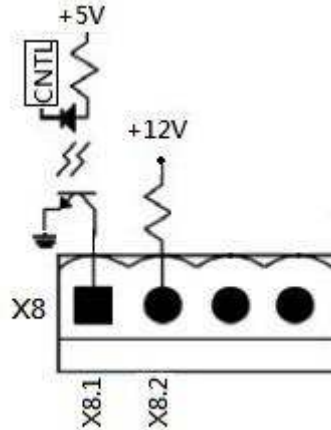


Figure 5-8 Battery breaker Control Port

Table 5-7 Description of Battery breaker Control Port

Name	Position	Description
Pin1	X8.1	Reserved
Pin 2	X8.2	Reserved

5.8 Other Communication Interface

The RS232 port and USB Port can use in UPS commissioning and service or monitor the Ups information by Monitoring Software .

This UPS has facility of internally fitted SNMP Card options.

6 Service

This chapter introduces the UPS service, including the service procedures of the power module, STS & control module, battery module and the replacement of air filter.

6.1 Replacement Procedures Of Power Module, STS & Control Module And Battery Module

6.1.1 Notes

1. Only the customer service engineers shall service the power modules, bypass module and battery modules.
2. Remove the power modules, bypass module and battery modules from top to bottom, so as to prevent cabinet toppling due to high centre of gravity.
3. To ensure safety, before servicing the power modules and bypass module, be sure to use a multimeter to verify that the DC bus capacitor voltage is lower than 60Vdc, and that the voltages between the earth and the components you are going to work on are under dangerous voltage values, that is, lower than 60Vdc or 42.4Vac peak value.
4. **The static transfer switch module is NOT hot pluggable.** It should be replaced only when the UPS is in maintenance bypass mode or completely powered off.
5. The power modules and bypass module should be serviced five minutes and installed in the cabinet again 10 minutes after they are removed.

6.1.2 Power Module Replacement Procedures

Confirm UPS is in normal mode and bypass function/source is available.

1. Enter to "menu" → control → Turn To Bypass → YES on the operator control and display panel for manually turn off the inverters. Then, the UPS transfers to bypass mode.
2. Turn ready switch to "■" position on replaceable power module.
3. Two minutes later, remove the fixing screws on both sides of the front panel of the module and pull the module out from the cabinet.

Note: The module will be blocked by a metal safe locker on the left side of the module when the module is pulled out halfway from the cabinet. At this point, you must press the metal safe locker before you continue to pulling the module out.

4. After servicing the module, confirm that the DIP switch of the module is set correctly and the ready switch is in unready state "■".
5. Push the module into the cabinet and tighten the screws on both sides. If it's more than one power module to re-install, please wait 10-second duration before installing another module.
6. Wait for two seconds before turning ready switch of the module to "■" position, it will be added into the system automatically and begin to work few seconds later.
7. Press manual → control → system turn on → YES on the operator control and display panel for two seconds to manually turn on the inverter mode.

6.1.3 STS & Control Module Service Procedures

The static transfer switch module is NOT hot pluggable.

Confirm the UPS is in normal mode and bypass function is available.

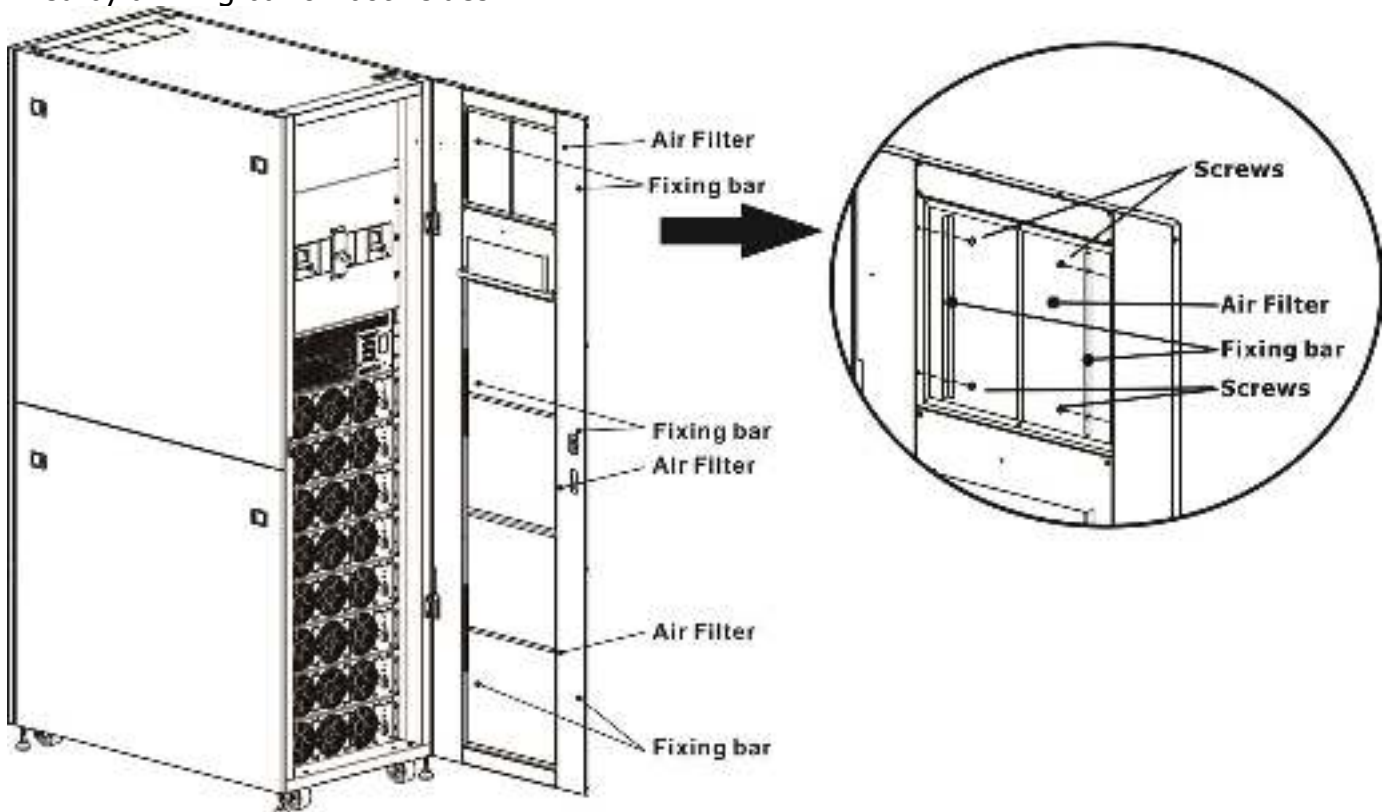
1. Press menu → control → Turn To Bypass → YES on the operator control and display panel for manually turn off the inverters, and the UPS transfers to bypass mode.
2. Turn on main switch and off maintenance bypass switch.
3. Two minutes later, remove the fixing screws on both sides of the front panel of the module and pull the module out from the cabinet.
4. After servicing the module, push the module into the cabinet and tighten the screws on both sides.
5. Turn on maintenance bypass switch and off main switch.
6. Wait for two seconds. Press menu → control → system turn on → YES on the operator control and display panel for two seconds to manually turn on the inverter mode.

6.1.4 Battery Module replacement Procedures

1. Disconnect each input connector of the battery module.
2. Remove the fixing screws on both sides of the front panel of the module, and pull out the battery module.
3. Push the new battery module into cabinet and fixing screws on both sides of the front panel.
4. Re-connect each input connector of the battery module.

6.2 Replacement Procedures Of Air Filter

As shown below figure, the UPS provides four air filters on the back of the front door. Each filter is fixed by a fixing bar on both sides.



The air filter replacement procedures are as follows:

1. Open the front door of the UPS to reveal the air filters on the back of the door.
2. Remove a fixing bar on either side of the air filter.
3. Remove the air filter, and insert a clean one.
4. Replace the fixing bar.

7 Specifications

The chapter provides the UPS specifications.

7.1 Conformity And Standards

The UPS has been designed to conform to the European and international standards listed in Table 7-1.

Table 7-1 European and international standards

Item	Normative reference
Uninterruptible power systems (UPS) –Part 1: General and safety requirements for UPS	IEC/EN62040-1
Electromagnetic compatibility (EMC) requirements for UPS	IEC/EN62040-2
Method of specifying the performance and test requirements of UPS	IEC/EN62040-3
Notes:	
ESD	IEC/EN 61000-4-2 Level 3
RS	IEC/EN 61000-4-3 Level 3
EFT	IEC/EN 61000-4-4 Level 3
Surge	IEC/EN 61000-4-5 Level 3
CS	IEC/EN 61000-4-6 Level 3
Power-Frequency Magnetic field	IEC/EN 61000-4-8 Level 3
Low Frequency Signals	IEC/EN 61000-2-2 Level 10V
Conduction	IEC/EN62040-2 Category C3
Radiation	IEC/EN62040-2 Category C3

7.2 Environmental Characteristics

Table 7-2 Environmental characteristics

Item	Unit	Specifications
Noise within 1 m	dB	Max. 75
Altitude	m	≤1000, derate power by 1% per 100m between 1000m and 2000m
Relative humidity	% RH	0 ~ 95, non condensing
Operating temperature	°C	0 ~ 40°C (Output capacity will be derated when temperature is over 30°C. It will be derated to 90% at 35°C and 80% at 40°C.)
Storage and transport temperature for UPS	°C	-15 ~ 60

7.3 Mechanical Characteristics

Table 7-3 Mechanical characteristics

30U

Model		30U-90	30U-120	30U-180
Rated power (kVA)	Unit	90	120	180
Dimensions, W x D x H	mm	600 x 1100 x 1475		
Weight	kg	675	335	437.5
Color	N/A	Black		
Protection degree, IEC (60529)	N/A	IP20 (front door and back door is open or closed)		

42U

Model		42U-120	42U-210
Rated power (kVA)	Unit	120	210
Dimensions, W x D x H	mm	600 x 1100 x 2010	
Weight	kg	932	7 Power Modules: 514.5 8 Power Modules: 549
Color	N/A	Black	
Protection degree, IEC (60529)	N/A	IP20 (front door and back door is open or closed)	

7.4 Electrical Characteristics (Input Rectifier)

Table 7-4 Rectifier AC input (mains)

Rated power (kVA)	Unit	30~210
Rated AC input voltage	Vac	380/400/415 (3-phase and sharing neutral with the bypass input)
Input voltage tolerance	Vac	305 ~ 477; 304 ~ 208 (output derated below 70%)
Frequency	Hz	50/60 (tolerance: 40Hz ~ 70Hz)
Power factor	kW/kVA, full load (half load)	0.99 (0.98)
Harmonic current distortion	THDI% FL	<3

7.5 Electrical Characteristics (Intermediate DC Circuit)

Table 7-5 Battery

Intermediate DC circuit						
Model		30U-90	42U-120	30U-120	30U-180	42U-210
Rated power (kVA)	Unit	90	120	120	180	210
Number of lead-acid cells	Nominal	216 (6cells x 36 12V battery block)				
	Maximum	240 (6cells x 40 12V battery block)				
	Minimum	192 (6cells x 32 12V battery block)				
Float voltage	V/cell	2.3V/cell Constant current and constant voltage charge mode				
Temperature compensation	mV/ /cl	-3.0 (Option)				
Ripple voltage	% V float	≤1				
Ripple current	% C10	≤5				
Boost voltage	VRLA	2.35V/cell Constant current and constant voltage charge mode				
EOD voltage	V/cell	1.67V/cell				
Battery charge	V/cell	Limit current and constant voltage charge mode Floating Voltage 2.3V/cell Boost charging 2.35V/cell				
Battery charging power ¹ max current	A	8 / per power module (adjustable)				
Note:						
1. At low input voltage the UPS recharge capability increases with load decrease (up to the maximum capacity indicated).						

7.6 Electrical Characteristics (Inverter Output)

Table 7-6 Inverter output (to critical load)

Rated power (kVA)	Unit	30 ~ 210
Rated AC voltage ¹	Vac	380/400/415 (three-phase four-wire, with neutral reference to the bypass neutral)
Frequency	Hz	50/60 Auto Selectable
Overload	%	105%~110% for 60min 110%~125% for 10min 126%~150% for 1min >150% for 200ms
Neutral current capability	%	170%
Steady state voltage stability	%	±1 (balanced load), ±2 (100% unbalanced load)
Total harmonic voltage	%	<1 (linear load), <4 (non-linear load3)
Synchronization window		+/- 1Hz, +/- 2Hz, +/- 4Hz (default: 4Hz)
Note:		
1. Factory setting is 400V. 380 or 415V is selectable by commissioning engineer.		

7.7 Electrical Characteristics (Bypass Mains Input)

Table 7-7 Bypass mains input

Rated power (kVA)	Unit	30 ~ 210
Rated AC voltage ¹	Vac	380/400/415 (Three-phase four-wire, sharing neutral with the rectifier input and providing neutral reference to the output)
Rated current	A	30U for 90KW → 171, 380V / 164, 400V / 157, 415V 42U for 120KW → 228, 380V / 218, 400V / 209, 415V 42U for 210KW → 397, 380V / 380, 365V / 329, 415V
Overload	%	105%~110% for 60min 110%~125% for 10min 126%~150% for 1min >150% for 200ms
Upstream protection, bypass line	N/A	Circuit breaker, rated up to 100% of nominal output current.
Current rating of neutral cable	A	1.7 × In
Frequency	Hz	50/60 Auto Selectable
Transfer time (between bypass and inverter)	ms	Synchronous transfer: ≤20ms
Bypass voltage tolerance	%Vac	Upper limit: +10, +15 or +20, default: +15 Lower limit: -10, -20, -30 default: -20 (delay time to accept steady bypass voltage: 10s)
Frequency Range	Hz	+/- 1Hz, +/- 2Hz, +/- 4Hz (default: 4Hz)
Note:		
1. Factory setting is 400V. 380V or 415V is selectable by commissioning engineer.		